

BIDDING DOCUMENT
for

THE PROCUREMENT OF

***Tourism Infrastructure Construction At Panini
Tapobhumi***

National Competitive Bidding (NCB)
Single-Stage: Two-Envelope Bidding Procedure

DIVISION FOREST OFFICE, ARGHAKHANCHI

Issued on : 03-02-2020

Invitation for Bids No.: DFO/W/03/076/77

NCB No.: DFO/W/03/076/77

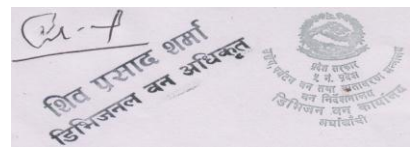

Abbreviations

BD	Bidding Document
BDF	Bidding Forms
BDS	Bid Data Sheet
BOQ	Bill of Quantities
COF	Contract Forms
DP	Development Partners
DoLIDAR	Department of Local Infrastructure Development and Agricultural Roads
ELI	Eligibility
EQC	Evaluation and Qualification Criteria
EXP	Experience
FIN	Financial
GCC	General Conditions of Contract
GoN	Government of Nepal
ICC	International Chamber of Commerce
IFB	Invitation for Bids
ITB	Instructions to Bidders
JV	Joint Venture
LIT	Litigation
NCB	National Competitive Bidding
PAN	Permanent Account Number
PPA	Public Procurement Act
PPMO	Public Procurement Monitoring Office
PPR	Public Procurement Regulations
PL	Profit & Loss
SBD	Standard Bidding Document
SCC	Special Conditions of Contract
TS	Technical Specifications
VAT	Value Added Tax
WRQ	Works Requirements

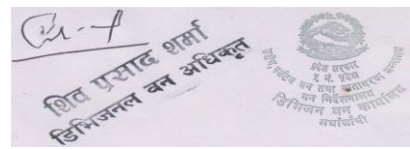
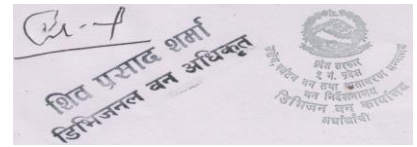

Table of Contents

Invitation for Bids	4
Part I: BIDDING PROCEDURES.....	6
Section I: Instructions to Bidders	9
Section II : Bid Data Sheet	35
Section III: Evaluation and Qualification Criteria	37
Section IV: Bidding Forms	48
Section V - Eligible Countries	74
Part II :BIDDING PROCEDURES.....	74
Section VI: Works Requirements.....	76
Section VI: Bill of Quantities.....	83
Part III: CONDITIONS OF CONTRACT AND CONTRACT FORMS.....	89
Section VIII: General Conditions of Contract	92
Section IX: Special Conditions of Contract	120
Section X: Contract Forms.....	125



Invitation for Bids

Province Government

Ministry of Industry, Tourism, Forest and Environment

Forest Directorate

Division Forest Office, Arghakhanchi

Invitation for Bids for the **Tourism Infrastructure Construction at Panini Tapobhumi**

Contract Identification No: DFOW/03/076/77

Date of publication: 03-02-2020

1. The Government of Province [GoP] **has allocated funds** towards the cost of Tourism Infrastructure Construction at Panini Tapobhumi and intends to apply part of the funds to cover eligible payments under the Contract **Construction of Multipurpose Auditorium Hall** Bidding is open to all eligible bidders as per Section V of bidding document..
2. **Division Forest Office, Arghakhanchi** invites electronic bids from eligible bidders for the construction of **Multipurpose Auditorium Hall** under National Competitive Bidding – Single Stage Two Envelope Bidding procedures.

Only eligible bidders with the following key qualifications should participate in this bidding:

- Minimum Average Annual Construction Turnover of the best 3 years within the last 10 years: 27000000
 - Minimum Work experience of similar size and nature: 3
3. Under the Single Stage, Two Envelope Procedure, Bidders are required to submit simultaneously two separate sealed envelopes, one containing (i) the Technical Bid and the other (ii) the Price Bid, both in turn enclosed in one sealed envelope as per the provision of ITB 21 of the Bidding Document.
 4. Eligible Bidders may obtain further information and inspect the Bidding Documents at the office of **Division Forest Office Arghakhanchi, Sandhikharka, dfoarghakhanchi@gmail.com, 077420109** or may visit PPMO e-GP system www.bolpatra.gov.np/egp.

Bidder who chooses to submit their bid electronically may purchase the hard copy of the bidding documents as mentioned above or may download the bidding documents for e-submission from PPMO's e-GP system www.bolpatra.gov.np/egp. Bidders, submitting their bid electronically, should deposit the cost of bidding document in the Project's Rajaswa (revenue) account as specified below .

Information to deposit the cost of bidding document in Bank:

Name of the Bank: Rastriya Banijya Bank, Sandhikharka Name of Office

:Division Forest Office

Office Code no. : 3070251015

Office Account no.:

1000200010000

Rajaswa (revenue) Shirshak no. 14229

5. Pre-bid meeting shall not be held.
6. Electronic bids must be submitted through PPMO's e-GP system www.bolpatra.gov.np/egp, on or before **17:00 Hrs 03-03-2020**. Bids received after this deadline will be rejected.
7. The bids will be opened in the presence of Bidders' representatives who choose to attend at **12:00 Hrs of 04-03-2020** at the office of **Division Forest Office, Arghakhanchi** Bids

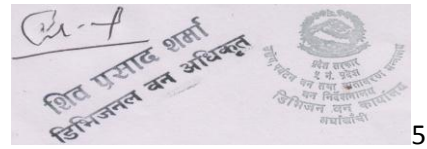

- must be valid for a period of **90 days** after bid opening and must be accompanied by a bid security or scanned copy of the bid security in pdf format in case of e-bid, amounting to a minimum of NRS **771090.26** , which shall be valid for 30 days beyond the validity period of the bid. i.e 01-07-2020.
8. If the last date of purchasing and /or submission falls on a government holiday, then the next working day shall be considered as the last date. In such case the validity period of the bid security shall remain the same as specified for the original last date of bid submission.

Table of Clauses

A. General	9
1. Scope of Bid	9
2. Source of Funds	9
3. Fraud and Corruption	9
4. Eligible Bidders	12
5. Eligible Materials, Equipment and Services	14
B. Contents of Bidding Documents	14
6. Sections of Bidding Document	14
7. Clarification of Bidding Document, Site Visit, Pre-Bid Meeting	14
8. Amendment of Bidding Document	15
9. Cost of Bidding	16
10. Language of Bid	16
11. Documents Comprising the Bid	16
12. Letter of Bid and Schedules	17
13. Alternative Bids	17
14. Bid Prices and Discounts	17
15. Currency of Bid and Payment	18
16. Documents Comprising the Technical Proposal	18
17. Documents Establishing the Qualifications of the Bidder	18
18. Period of Validity of Bids	18
19. Bid Security	19
20. Format and Signing of Bid	20
D. Submission and Opening of Bids	21
21. Sealing and Marking of Bids	21
22. Deadline for Submission of Bids	23
23. Late Bids	23
24. Withdrawal, and Modification of Bids	23
25. Bid Opening	25
E. Evaluation and Comparison of Bids	27
26. Confidentiality	27
27. Clarification of Bids	27
28. Deviations, Reservations, and Omissions	27
29. Examination of Technical Bid	27
30. Determination of Responsiveness of Technical Bid	28

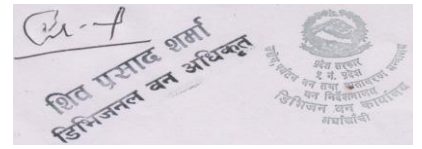

31. Nonconformities Errors, and Omissions	29
32 Qualification of the Bidder	29
33. Correction of Arithmetical Errors	29
34 Subcontractors.....	30
35. Evaluation of Price Bids	30
36. Comparison of Bids.....	31
37. Employer's Right to Accept Any Bid, and to Reject Any or All Bids	31
38. Award Criteria	32
39. Letter of Intent to Award the Contract/Notification of Award	32
40. Performance Security	32
41 Signing of Contract	33
42. Complaint and Review	33

Section I: Instructions to Bidders

A. General	
1. Scope of Bid	<p>1.1 In connection with the Invitation for Bids indicated in the Bid Data Sheet (BDS), the Employer, as indicated in the BDS, issues this Bidding Document for the procurement of Works as specified in Section VI (Works Requirements). The name, identification, and number of Contracts of the National Competitive Bidding (NCB) are provided in the BDS.</p> <p>1.2 Throughout this Bidding Document:</p> <p>(a) the term “in writing” means communicated in written form and delivered against receipt;</p> <p>(b) except where the context requires otherwise, words indicating the singular also include the plural and words indicating the plural also include the singular; and</p> <p>(c) “day” means calendar day.</p>
2. Source of Funds	<p>2.1 GoN Funded: In accordance with its annual program and budget, approved by the GoN, the implementing agency indicated in the BDS plans to apply a portion of the allocated budget to eligible payments under the contract(s) for which this Bidding Document is issued.</p> <p style="text-align: center;">Or</p> <p>Public Entities' own Resource Funded: In accordance with its annual program and budget, approved by the public entity, the implementing agency indicated in the BDS plans to apply a portion of the allocated budget to eligible payments under the contract(s) for which this Bidding Document is issued.</p> <p>.</p> <p>2.2 DP Funded: Payment by the DP will be made only at the request of the GoN and upon approval by the DP in accordance with the terms and conditions of the financing agreement between the GoN and the DP (hereinafter called the “Loan/Grant Agreement”), and will be subject in all respects to the terms and conditions of that Loan/Grant Agreement. No party other than the GoN shall derive any rights from the Loan Agreement or have any claim to the funds.</p>
3. Fraud and Corruption	<p>3.1 Procuring Entities as well as Bidders, suppliers and contractors and their sub-contractors shall adhere to the highest standard of ethics during the procurement and execution of such contracts. In pursuance of this;:</p> <p>(a) the Employer adopts, for the purposes of this provision, the terms as defined below:</p> <p>(i) “corrupt practice” means the offering, giving, receiving, or soliciting, directly or indirectly, anything of value to influence improperly the actions of another party;</p> <p>(ii) “fraudulent practice” means any act or omission, including a misrepresentation, that knowingly or</p>

recklessly misleads, or attempts to mislead, a party to obtain a financial or other benefit or to avoid an obligation;

(iii) “coercive practice” means impairing or harming, or threatening to impair or harm, directly or indirectly, any party or the property of the party to influence improperly the actions of a party;

(iv) “collusive practice” means an arrangement between two or more parties designed to achieve an improper purpose, including influencing improperly the actions of another party.

v) “obstructive practice” means (a) deliberately destroying, falsifying, altering, or concealing of evidence material to an investigation; (b) making false statements to investigators in order to materially impede an investigation; (c) failing to comply with requests to provide information, documents, or records in connection with an investigation; (d) threatening, harassing, or intimidating any party to prevent it from disclosing its knowledge of matters relevant to the investigation or from pursuing the investigation; or (e) materially impeding GoN/DP’s contractual rights of audit or access to information; and

vi) “integrity violation” is any act which violates Anticorruption Policy, including (i) to (v) above and the following: abuse, conflict of interest, violations of GoN/DP sanctions, retaliation against whistleblowers or witnesses, and other violations of Anticorruption Policy, including failure to adhere to the highest ethical standard.

(b) the Employer will reject a proposal for award if it determines that the Bidder recommended for award has, directly or through an agent, engaged in corrupt, fraudulent, collusive, coercive, or obstructive practices or other integrity violations in competing for the contract;

(c) DP will cancel the portion of the financing allocated to a contract if it determines at any time that representative(s) of the GoN or of a beneficiary of DP-financing engaged in corrupt, fraudulent, collusive, or coercive practices or other integrity violations during the procurement or the execution of that contract, without the GoN having taken timely and appropriate action satisfactory to DP to remedy the situation.

(d) DP will impose remedial actions on a firm or an individual, at any time, in accordance with DP’s Anticorruption Policy and related Guidelines (as amended from time to time), including declaring ineligible, either indefinitely or for a stated period of time, to participate in DP-financed, -administered, or -supported activities or to benefit from an DP-financed, -administered, or -supported contract, financially or otherwise, if it at any time determines that the firm or individual has, directly or through an agent, engaged in corrupt, fraudulent, collusive, coercive, or obstructive practices or other integrity violations; and

(e) The Contractor shall permit the GoN/DP to inspect the Contractor’s accounts and records relating to the performance of the Contractor and

	<p>to have them audited by auditors appointed by the GoN/DP, if so required by the GoN/DP.</p> <p>3.2 The Bidder shall not carry out or cause to carry out the following acts with an intention to influence the implementation of the procurement process or the procurement agreement :</p> <ul style="list-style-type: none"> (a) give or propose improper inducement directly or indirectly, (b) distortion or misrepresentation of facts, (c) engaging in corrupt or fraudulent practice or involving in such act, (d) interference in participation of other competing bidders, (e) coercion or threatening directly or indirectly to cause harm to the person or the property of any person to be involved in the procurement proceedings, (f) collusive practice among bidders before or after submission of bids for distribution of works among bidders or fixing artificial/uncompetitive bid price with an intention to deprive the Employer the benefit of open competitive bid price, (g) Contacting the Employer with an intention to influence the Employer with regards to the bids or interference of any kind in examination and evaluation of the bids during the period from the time of opening of the bids until the notification of award of contract. <p>3.3 PPMO, on the recommendation of the Procuring Entity may blacklist a Bidder for a period of one (1) to three (3) years for its conduct including on the following grounds and seriousness of the act committed by the bidder:</p> <ul style="list-style-type: none"> (a) if convicted by a court of law in a criminal offence which disqualifies the Bidder from participating in the contract, (b) if it is established that the contract agreement signed by the Bidder was based on false or misrepresentation of Bidder's qualification information, (c) if it at any time determines that the firm has, directly or through an agent, engaged in corrupt, fraudulent, collusive, coercive, or obstructive practices in competing for, or in executing, a GoN/DP-financed contract. (d) if the Successful Bidder fails to sign the Contract.
--	--

	<p>the disqualification of all Bids in which it is involved. However, subject to any finding of a conflict of interest in terms of ITB 4.3 (a)-(d) above, this does not limit the participation of the same subcontractor in more than one bid; or</p> <p>(f) a Bidder or any of its affiliated entity, participated as a consultant in the preparation of the design or technical specifications of the works that are the subject of the Bid; or</p> <p>(g) a Bidder was affiliated with a firm or entity that has been hired (or is proposed to be hired) by the Employer as Engineer for the Contract.</p>
	<p>4.4 A firm that is under a declaration of ineligibility by the GoN in accordance with ITB 3, at the date of the deadline for bid submission or thereafter, shall be disqualified. A firm shall not be eligible to participate in any procurement activities under an DP-financed, -administered, or -supported project while under temporary suspension or debarment by DP pursuant to the DP's Anticorruption Policy (see ITB 3), whether such debarment was directly imposed by the DP, or enforced by other DPs pursuant to the Agreement for Mutual Enforcement of Debarment Decisions. A bid from a temporary suspended or debarred firm will be rejected.</p>
	<p>4.5 Enterprises owned by Government shall be eligible only if they can establish that they are legally and financially autonomous and operate under commercial law, and that they are not a dependent agency of the GoN.</p>
	<p>4.6 Bidders shall provide such evidence of their continued eligibility satisfactory to the Employer, as the Employer shall reasonably request.</p>
	<p>4.7 Firms shall be excluded in any of the cases, if</p> <p>(a) by an act of compliance with a decision of the United Nations Security Council taken under Chapter VII of the Charter of the United Nations, Nepal prohibits any import of goods or Contracting of works or services from that country or any payments to persons or entities in that country. Where Nepal prohibits payments to a particular firm or for particular goods by such an act of compliance, that firm may be excluded;</p> <p>(b) DP Funded: as a matter of law or official regulation, Nepal prohibits commercial relations with that country, provided that the DP is satisfied that such exclusion does not preclude effective competition for the supply of goods or related services required;</p> <p>(c) DP Funded: a firm sanctioned or temporarily suspended by the DP in relation to their guidelines or appropriate provisions on preventing and combating fraud and corruption in projects financed by them.</p>
	<p>4.8 In case a prequalification process has been conducted prior to the bidding process, this bidding is open only to prequalified Bidders.</p>

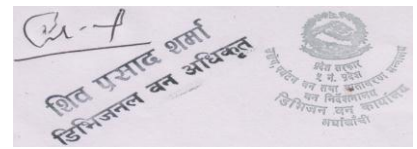

<p>5. Eligible Materials, Equipment and Services</p>	<p>5.1 The materials, equipment and services to be supplied under the Contract shall have their origin in any source countries as defined in accordance with Section V (Eligible Countries) and all expenditures under the Contract will be limited to such materials, equipment, and services. At the Employer's request, Bidders may be required to provide evidence of the origin of materials, equipment and services.</p> <p>5.2 For purposes of ITB 5.1 above, "origin" means the place where the materials and equipment are mined, grown, produced or manufactured, and from which the services are provided. Materials and equipment are produced when, through manufacturing, processing, or substantial or major assembling of components, a commercially recognized product results that differs substantially in its basic characteristics or in purpose or utility from its components.</p>
<p>B. Contents of Bidding Documents</p>	
<p>6. Sections of Bidding Document</p>	<p>6.1 The Bidding Document consist of Parts I, II, and III, which include all the Sections indicated below, and should be read in conjunction with any Addenda issued in accordance with ITB 8.</p> <p>PART I Bidding Procedures</p> <ul style="list-style-type: none"> Section I Instructions to Bidders (ITB) Section II Bid Data Sheet (BDS) Section III Evaluation and Qualification Criteria (EQC) Section IV Bidding Forms (BDF) Section V Eligible Countries <p>PART II Requirements</p> <ul style="list-style-type: none"> Section VI Works Requirements (WRQ) Section VII Bill of Quantities (BOQ) <p>PART III Conditions of Contract and Contract Forms</p> <ul style="list-style-type: none"> Section VIII General Conditions of Contract (GCC) Section IX Special Conditions of Contract (SCC) Section X Contract Forms (COF) <p>6.2 The Invitation for Bids issued by the Employer is not part of the Bidding Document.</p> <p>6.3 The Employer is not responsible for the completeness of the Bidding Document and their Addenda, if they were not obtained directly from the source stated by the Employer in the Invitation for Bids.</p> <p>6.4 The Bidder is expected to examine all instructions, forms, terms, and specifications in the Bidding Document and to furnish with its bid all information and documentation as is required by the Bidding Documents. Failure to furnish all information or documentation required by the Bidding Document may result in the rejection of the bid.</p>
<p>7. Clarification of Bidding Document, Site Visit, Pre-Bid Meeting</p>	<p>7.1 A prospective Bidder requiring any clarification of the Bidding Document shall contact the Employer in writing at the Employer's address indicated in BDS or raise any question or curiosity during the pre-bid meeting if provided for in accordance with ITB 7.4. The Employer will respond in writing to any request for clarification, provided that such request is</p>

	<p>received within the period as mentioned in ITB 7.5. The Employer shall forward copies of its response to all Bidders who have acquired the Bidding Document in accordance with ITB 6.3, including a description of the inquiry but without identifying its source. Should the Employer deem it necessary to amend the Bidding Document as a result of a request for clarification, it shall do so following the procedure under ITB 8 and ITB 22.2.</p>
	<p>7.2 The Bidder is advised to visit and examine the Site of Works and its surroundings and obtain for itself, on its own risk and responsibility, all information that may be necessary for preparing the bid and entering into a Contract for construction of the Works. The costs of visiting the Site shall be at the Bidder's own expense.</p>
	<p>7.3 The Bidder and any of its personnel or agents will be granted permission by the Employer to enter upon its premises and lands for the purpose of such visit, but only upon the express condition that the Bidder, its personnel, and agents will release and indemnify the Employer and its personnel and agents from and against all liability in respect thereof, and will be responsible for death or personal injury, loss of or damage to property, and any other loss, damage, costs, and expenses incurred as a result of the inspection.</p>
	<p>7.4 The Bidder's designated representative is invited to attend a pre-bid meeting, if provided for in the BDS. The purpose of the meeting will be to clarify issues and to answer questions on any matter that may be raised at that stage.</p>
	<p>7.5 The Bidder is requested, to submit any questions in writing, to reach the Employer as mentioned in BDS.</p>
	<p>7.6 Minutes of the pre-bid meeting, including the text of the questions raised, without identifying the source, and the responses given, together with any responses prepared after the meeting, will be transmitted promptly to all Bidders who have acquired the Bidding Document in accordance with ITB 6.3. Any modification to the Bidding Document that may become necessary as a result of the pre-bid meeting shall be made by the Employer exclusively through the issue of an addendum pursuant to ITB 8 and not through the minutes of the pre-bid meeting.</p>
	<p>7.7 Non attendance at the pre-bid meeting will not be a cause for disqualification of a Bidder.</p>
<p>8. Amendment of Bidding Document</p>	<p>8.1 At any time prior to the deadline for submission of bids, the Employer may amend the Bidding Document by issuing agenda.</p>
	<p>8.2 Any addendum issued shall be part of the Bidding Document and shall be communicated in writing to all who have obtained the Bidding Document from the Employer in accordance with ITB 6.3.</p>
	<p>8.3 To give prospective Bidders reasonable time in which to take an addendum into account in preparing their Bids, the Employer may, at its</p>

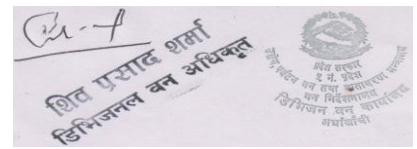

	discretion, extend the deadline for the submission of Bids, pursuant to ITB 22.2
C. Preparation of Bids	
9. Cost of Bidding	9.1 The Bidder shall bear all costs associated with the preparation and submission of its Bid, and the Employer shall in no case be responsible or liable for those costs, regardless of the conduct or outcome of the bidding process.
10. Language of Bid	10.1 The Bid, as well as all correspondence and documents relating to the bid exchanged by the Bidder and the Employer, shall be written in the language specified in the BDS . Supporting documents and printed literature that are part of the Bid may be in another language provided they are accompanied by an accurate translation of the relevant passages in the language specified in the BDS , in which case, for purposes of interpretation of the Bid, such translation shall govern.
11. Documents Comprising the Bid	<p>11.1 The Bid shall comprise two envelopes submitted simultaneously, one called the Technical Bid containing the documents listed in ITB 11.2 and the other the Price Bid containing the documents listed in ITB 11.3, both envelopes enclosed together in an outer single envelope.</p> <p>11.2 The Technical Bid shall comprise the following:</p> <ul style="list-style-type: none"> (a) Letter of Technical Bid; (b) Bid Security in accordance with ITB 19; (c) alternative Technical Bid, at Bidder's option and if permissible, in accordance with ITB 13; (d) written confirmation authorizing the signatory of the Bid to commit the Bidder, in accordance with ITB 20.2; (e) documentary evidence in accordance with ITB 17, establishing the Bidder's qualifications to perform the contract; (f) Technical Proposal in accordance with ITB 16; (g) Bids submitted by a Joint Venture shall include a copy of the Joint Venture Agreement entered into by all partners. Alternatively, a Letter of Intent to execute a Joint Venture Agreement in the event of a successful Bid shall be signed by all partners and submitted with the Bid, together with a copy of the proposed agreement. The Joint Venture agreement, or letter of intent to enter into a Joint Venture including a draft agreement shall indicate at least the parts of the Works to be executed by the respective partners; and (h) any other required documents, which is not against the provision of Procurement Act/Regulation/Directives and Standard Bidding Document issued by PPMO as specified in the BDS. <p>11.3 The Price Bid shall comprise the following:</p> <ul style="list-style-type: none"> (a) Letter of Price Bid; (b) completed Bill of Quantities(BoQ), in accordance with ITB 12 and

	<p>ITB 14, or as stipulated in the BDS;</p> <p>(c) alternative price Bids, at Bidder's option and if permissible, in accordance with ITB 13;</p> <p>(d) Any other document required in the BDS.</p> <p>11.4 The Bidder is solely responsible for the authenticity of the submitted documents.</p>
<p>12. Letter of Bid and Schedules</p>	<p>12.1 The Letters of Technical Bid and Price Bid, Schedules, and all documents listed under ITB 11, shall be prepared using the relevant forms in Section IV (Bidding Forms) and in Section VII (Bill of Quantities). The forms must be completed without any alterations to the text, and no substitutes shall be accepted. All blank spaces shall be filled in with the information requested.</p>
<p>13. Alternative Bids</p>	<p>13.1 Unless otherwise specified in the BDS, alternative bids shall not be considered.</p> <p>13.2 When alternative times for completion are explicitly invited, a statement to that effect will be included in the BDS, as will the method of evaluating different times for completion.</p> <p>13.3 When specified in the BDS pursuant to ITB 13.1, and subject to ITB 13.4 below, Bidders wishing to offer technical alternatives to the requirements of the Bidding Document must first price the Employer's design as described in the Bidding Document and shall further provide all information necessary for a complete evaluation of the alternative by the Employer, including drawings, design calculations, technical specifications, breakdown of prices, and proposed construction methodology and other relevant details. Only the technical alternatives, if any, of the lowest evaluated Bidder conforming to the basic technical requirements shall be considered by the Employer.</p> <p>13.4 When specified in the BDS, Bidders are permitted to submit alternative technical solutions for specified parts of the Works. Such parts will be identified in the BDS and described in Section VI (Works Requirements). The method for their evaluation will be stipulated in Section III (Evaluation and Qualification Criteria).</p>
<p>14. Bid Prices and Discounts</p>	<p>14.1 The prices and discounts quoted by the Bidder in the Letter of Price Bid and in the Schedules shall conform to the requirements specified below.</p> <p>14.2 The Bidder shall submit a bid for the whole of the works described in ITB 1.1 by filling in prices for all items of the Works, as identified in Section VII (Bill of Quantities). In case of Unit Rate Contracts, the Bidder shall fill in rates and prices for all items of the Works described in the Bill of Quantities. Items against which no rate or price is entered by the Bidder will not be paid for by the Employer when executed and shall be deemed covered by the rates for other items and prices in the Bill of Quantities.</p> <p>14.3 The price to be quoted in the Letter of Price Bid shall be the total price of</p>

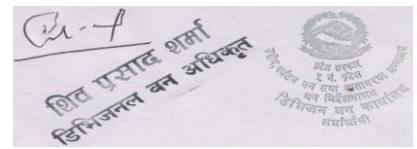

	<p>the Bid, excluding any discounts offered.</p> <p>14.4 The Bidder shall quote any discounts and the methodology for their application in the Letter of Price Bid, in accordance with ITB 12.1.</p> <p>14.5 If so indicated in ITB 1.1, bids are invited for individual Contracts or for any combination of Contracts (packages). Bidders wishing to offer any price reduction for the award of more than one Contract shall specify in their bid the price reductions applicable to each package, or alternatively, to individual Contracts within the package. Price reductions or discounts shall be submitted in accordance with ITB 14.4, provided the Bids for all Contracts are submitted and opened at the same time.</p> <p>14.6 Unless otherwise provided in the BDS and the Conditions of Contract, the prices quoted by the Bidder shall be fixed. If the prices quoted by the Bidder are subject to adjustment during the performance of the Contract in accordance with the provisions of the Conditions of Contract, the Bidder shall furnish the indices and weightings for the price adjustment formulae in the Table of Adjustment Data in Section IV (Bidding Forms) and the Employer may require the Bidder to justify its proposed indices and weightings.</p> <p>14.7 All duties, taxes, and other levies payable by the Contractor under the Contract, or for any other cause, as of the date 30 days prior to the deadline for submission of bids, shall be included in the rates and prices and the total bid price submitted by the Bidder.</p>
15. Currency of Bid and Payment	15.1 The currency of the bid and payment shall be in Nepalese Rupees.
16. Documents Comprising the Technical Proposal	16.1 The Bidder shall furnish a Technical Proposal including a statement of work methods, equipment, personnel, schedule and any other information as stipulated in Section IV (Bidding Forms), in sufficient detail to demonstrate the adequacy of the Bidders' proposal to meet the work requirements and the completion time.
17. Documents Establishing the Qualifications of the Bidder	17.1 To establish its qualifications to perform the Contract in accordance with Section III (Evaluation and Qualification Criteria) the Bidder shall provide the information requested in the corresponding information sheets included in Section IV (Bidding Forms).
18. Period of Validity of Bids	<p>18.1 Bids shall remain valid for the period specified in the BDS after the bid submission deadline date prescribed by the Employer. A bid valid for a shorter period shall be rejected by the Employer as nonresponsive.</p> <p>18.2 In exceptional circumstances, prior to the expiration of the bid validity period, the Employer may request Bidders to extend the period of validity of their Bids. The request and the responses shall be made in writing. If a bid security is requested in accordance with ITB 19, it shall also be extended 30 days beyond the deadline of the</p>

	<p>extended validity period. A Bidder may refuse the request without forfeiting its bid security. A Bidder granting the request shall not be required or permitted to modify its Bid and to include any additional conditions against the provisions specified in Bid Documents.</p>
<p>19. Bid Security</p>	<p>19.1 The Bidder shall furnish as part of its bid, in original form, a bid security as specified in the BDS. In case of e-submission of bid, the Bidder shall upload scanned copy of Bid security letter at the time of electronic submission of the bid. The Bidder accepts that the scanned copy of the Bid security shall, for all purposes, be equal to the original. The details of original Bid Security and the scanned copy submitted with e-bid should be the same otherwise the bid shall be non-responsive.</p>
	<p>19.2 The bid security shall be, at the Bidder's option, in any of the following forms:</p> <ul style="list-style-type: none"> (a) an unconditional bank guarantee from Commercial Bank or Financial Institution eligible to issue Bank Guarantee as per prevailing Law or; (b) a cash deposit voucher in the Employer's Account as specified in BDS. <p>In the case of a bank guarantee, the bid security shall be submitted either using the Bid Security Form included in Section IV (Bidding Forms) or in another Form acceptable to the employer. The form must include the complete name of the Bidder. The bid security shall be valid for minimum thirty (30) days beyond the original validity period of the bid, or beyond any period of extension if requested under ITB 18.2.</p>
	<p>19.3 The bid security issued by any foreign Bank outside Nepal must be counter guaranteed by Commercial Bank or Financial Institution eligible to issue Bank Guarantee as per prevailing Law in Nepal.</p>
	<p>19.4 Any bid not accompanied by an enforceable and substantially compliant bid security shall be rejected by the Employer as nonresponsive. In case of e- Submission, if the scanned copy of an acceptable Bid Security letter is not uploaded with the electronic Bid then Bid shall be rejected.</p>
	<p>19.5 The bid security of unsuccessful Bidders shall be returned within three days, once the successful Bidder's furnishing of the required performance security and signing of the Contract Agreement pursuant to ITB 40.1 and 41.1</p>
	<p>19.6 The bid security shall be forfeited if:</p> <p>GoN funded :</p> <ul style="list-style-type: none"> (a) a Bidder requests for withdrawal or modification of its bid, except as provided in ITB 18.2: <ul style="list-style-type: none"> (i) during the period of bid validity specified by the Bidder on the Letter of Technical Bid and Price Bid, in case of electronic submission; (ii) from the period twenty-four hours prior to bid submission deadline

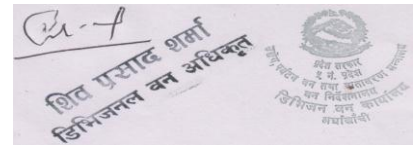

	<p>up to the period of bid validity specified by the Bidder on the Letter of Technical Bid and Price Bid, in case of hard copy submission.</p> <p>(b)a Bidder changes the prices or substance of the bid while providing information pursuant to clause 27.1;</p> <p>(c) a Bidder involves in fraud and corruption pursuant to clause 3.1;</p> <p>(d) the successful Bidder fails to:</p> <ul style="list-style-type: none"> (i) furnish a performance security in accordance with ITB 40.1; (ii) sign the Contract in accordance with ITB 41.1; or (iii) accept the correction of arithmetical errors pursuant to clause 33.1 <p>DP funded:</p> <p>The bid security shall be forfeited</p> <ul style="list-style-type: none"> (a) if a Bidder withdraws its bid during the period of bid validity specified by the Bidder on the Letters of Technical Bid and Price Bid, except as provided in ITB 18.2; or (b) if the successful Bidder fails to <ul style="list-style-type: none"> (i) furnish a performance security in accordance with ITB 40.1; or (ii) sign the Contract in accordance with ITB 41.1; (iii) accept arithmetical corrections in accordance with ITB 33.1; <p>19.7 The Bid Security of a Joint Venture shall be in the name of the Joint Venture that submits the bid. If the Joint Venture has not been legally constituted at the time of bidding, the Bid Security shall be in the names of all future partners as named in the letter of intent mentioned in ITB 4.1.</p>
<p>20. Format and Signing of Bid</p>	<p>20.1 The Bidder shall prepare one original set of the Technical Bid and one original of the Price Bid comprising the Bid as described in ITB 11 and clearly mark it “ORIGINAL – TECHNICAL BID” and “ORIGINAL – PRICE BID.” Alternative bids, if permitted in accordance with ITB 13, shall be clearly marked “ALTERNATIVE”. In addition, the Bidder shall submit copies of the bid in the number specified in the BDS, and clearly mark each of them “COPY.” In the event of any discrepancy between the original and the copies, the original shall prevail.</p> <p>In case of e-submission of bid, the Bidder shall submit his bid electronically in PDF or web forms files as specified in ITB Clause 21.1(b).</p> <p>20.2 The original and all copies of the bid shall be typed or written in indelible ink and shall be signed by a person duly authorized to sign on behalf of the Bidder. This authorization shall consist of a written confirmation as specified in the BDS and shall be attached to the bid. The name and position held by each person signing the authorization must be typed or printed below the signature. All pages of the bid, except for un amended printed literature, shall be signed or initialed by the person signing the bid.</p> <p>20.3 Any amendments such as interlineations, erasures, or overwriting shall be</p>

	valid only if they are signed or initialed by the person signing the bid.								
D. Submission and Opening of Bids									
21. Sealing and Marking of Bids	<p>21.1 Unless otherwise specified in BDS, Bidders shall submit their bids by electronic or by mail/by hand/by courier. Procedures for submission, sealing and marking are as follows:</p> <p>(a) Bidders submitting bids by mail, by hand or by courier</p> <p>shall enclose the original of the Technical Bid, and the original of the Price Bid and each copy of the Technical Bid and Price Bid, including alternative bids, if permitted in accordance with ITB 13, in separate sealed envelopes, duly marking the envelopes as “ORIGINAL TECHNICAL BID”, “ORIGINAL – PRICE BID”, “ALTERNATIVE” and “COPY No. – TECHNICAL BID” and “COPY NO. PRICE BID” These envelopes containing the original and the copies shall then be enclosed in one single envelope.</p> <p>(b) Bidders submitting Bids electronically shall follow the electronic bid submission procedure specified in this clause.</p> <ol style="list-style-type: none"> i. The bidder is required to register in the e-GP system https://www.bolpatra.gov.np/egp following the procedure specified in e-GP guideline. ii. Interested bidders may either purchase the bidding document from the Employer's office as specified in the Invitation for Bid (IFB) or bidders may download the IFB and bidding document from e-GP system. iii. The registered bidders need to maintain their profile data required during preparation of bids. iv. In order to submit their bids the cost of the bidding document can be deposited as specified in IFB. In addition, electronic scanned copy (.pdf format) of the bank deposit voucher/cash receipt should also be submitted along with the technical bid. v. The bidder can prepare their technical and price bids using data and documents maintained in bidder's profile and forms/format provided in bidding document by Employer. The bidder may submit bids as a single entity or as a joint venture. The bidder submitting bid in joint venture shall have to upload joint venture agreement along with partner(s) Bolpatra ID provided during bidder's registration. vi. Bidders (all partners in case of JV) should update their profile data and documents required during preparation and submission of their technical bids. vii. In case of bid submission in JV, the consent of the partners shall be obtained through the confirmation link sent to the registered email address and the partners shall have to acknowledge their confirmation. <p style="text-align: center;">The required forms and documents shall be part of technical bids.</p> <table border="1" style="width: 100%; border-collapse: collapse;"> <thead> <tr> <th style="width: 5%;">No.</th> <th style="width: 40%;">Document</th> <th style="width: 30%;">Requirement</th> <th style="width: 25%;">Remarks</th> </tr> </thead> <tbody> <tr> <td> </td> <td> </td> <td> </td> <td> </td> </tr> </tbody> </table>	No.	Document	Requirement	Remarks				
No.	Document	Requirement	Remarks						

	<p>process. The Bidders are fully responsible to use the e-submission facility properly in e-GP system as per specified procedures and in no case the Employer shall be held liable for Bidder's inability to use this facility.</p> <p>cc) When a bidder submits electronic bid through the PPMO e-GP portal, it is assumed that the bidder has prepared the bid by studying and examining the complete set of the Bidding documents including specifications, drawings and conditions of contract.</p> <p>21.2. The inner and outer envelopes shall:</p> <p>(aa) bear the name and address of the Bidder;</p> <p>(bb) be addressed to the Employer as provided in BDS 22.1;</p> <p>(cc) bear the specific identification of this bidding process indicated in BDS 1.1; and</p> <p>21.3 The outer envelope and the inner envelope containing Technical Proposal shall bear a warning not to open before the time and date for the opening of Technical Bid in accordance with ITB 25.1.</p> <p>21.4 The inner envelope containing the Price Bid shall bear a warning not to open until advised by the Employer in accordance with ITB 25.7</p> <p>21.5 If all envelopes are not sealed and marked as required, the Employer will assume no responsibility for the misplacement or premature opening of the bid.</p>
<p>22. Deadline for Submission of Bids</p>	<p>22.1 Bids must be received by the Employer at the address and no later than the date and time indicated in the BDS.</p> <p>In case of e-submission, the standard time for e-submission is Nepal Standard Time as set out in the server. The e-procurement system will accept the e-submission of bid from the date of publishing of notice and will automatically not allow the e-submission of bid after the deadline for submission of bid.</p> <p>22.2 The Employer may, at its discretion, extend the deadline for the submission of bids by amending the Bidding Document in accordance with ITB 8, in which case all rights and obligations of the Employer and Bidders previously subject to the deadline shall thereafter be subject to the deadline as extended.</p>
<p>23. Late Bids</p>	<p>23.1 The Employer shall not consider any bid that arrives after the deadline for submission of bids, in accordance with ITB 22. Any bid received by the Employer after the deadline for submission of bids shall be declared late, rejected, and returned unopened to the Bidder.</p>
<p>24. Withdrawal, and Modification of Bids</p>	<p>24.1 A Bidder may withdraw, or modify its bid- Technical or Price - after it has been submitted either in hard copy or by e-submission. Once a Bid is withdrawn, bidder shall not be able to submit another bid for this bidding process. Procedures for withdrawal or modification of submitted bids are as follows:</p> <p>(i) Bids submitted in Hard Copy GoN Funded:</p>

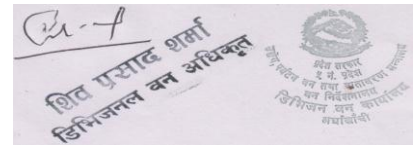

	<p>a) Bidders may withdraw or modify its bids by sending a written notice in a sealed envelope, duly signed by an authorized representative, and shall include a copy of the authorization in accordance with ITB 20.2. The corresponding modification of the bid must accompany the respective written notice. All notices must be:</p> <ul style="list-style-type: none">(aa) prepared and submitted in accordance with ITB 20 and ITB 21, and in addition, the respective envelopes shall be clearly marked “WITHDRAWAL”, “MODIFICATION”, and(bb) received by the Employer twenty four hour prior to the deadline prescribed for submission of bids, in accordance with ITB 22. <p>DP Funded:</p> <p>A Bidder may withdraw or modify its Bid – Technical or Price – after it has been submitted by sending a written notice, duly signed by an authorized representative, and shall include a copy of the authorization in accordance with ITB 20.2, (except that withdrawal notices do not require copies). The corresponding modification of the Bid must accompany the respective written notice. All notices must be</p> <ul style="list-style-type: none">i) prepared and submitted in accordance with ITB 20 and ITB 21 (except that withdrawal notices do not require copies), and in addition, the respective envelopes shall be clearly marked “WITHDRAWAL”, and “MODIFICATION”, andii) received by the Employer prior to the deadline prescribed for submission of Bids, in accordance with ITB 22. <p>ii) E-submitted bids.</p> <ul style="list-style-type: none">a) Bidder may submit modification or withdrawal prior to the deadline prescribed for submission of bids through e-GP system by using the forms and instructions provided by the system.
	<p>24.2 Bids requested to be withdrawn in accordance with ITB 24.1 shall not be opened. In case of hard copy submission, the Bid will be returned unopened to the Bidders.</p>
	<p>24.3 The following provisions apply for withdrawal or modification of the Bids:</p> <p>GoN Funded:</p> <ul style="list-style-type: none">(i) In case of bids submitted in hard copy no bid shall be withdrawn or modified in the interval between 24 hours prior to the deadline for submission of bids and the expiration of the period of bid validity specified by the Bidder on the Letter of Bid or any extension thereof.(ii) In case of e-submitted bids no bids shall be withdrawn or modified in the interval between deadline for submission of bids and the expiration of the period of bid validity specified by the Bidder on the Letter of Technical Bid and Price Bid or any extension thereof. <p>DP Funded:</p> <p>No Bid may be withdrawn or modified in the interval between the deadline for submission of Bids and the expiration of the period of bid validity specified by the Bidder on the Letters of Technical Bid and Price Bid or any extension thereof.</p>

	<p>24.4 Except in case of any modification or correction in bid document made by procuring entity, Bidder may submit request for withdrawal or modification only one time.</p> <p>24.5 In case of hard copy bid, no bid may be withdrawn if the bid has already been modified; except in case of any modification or correction in bid document by procuring entity.</p> <p>24.6 Request for withdrawal or modification must be made through the same medium of submission. Request for withdrawal or modifications through different medium shall not be considered.</p>
25. Bid Opening	<p>25.1 The Employer shall open the Technical Bids in public at the address, on the date and time specified in the BDS in the presence of Bidders` designated representatives who choose to attend. The Price Bids will remain unopened and will be held in custody of the Employer until the specified time of their opening. If the Technical Bid and Price Bid are submitted together in one envelope, the Employer shall reject the entire Bid.</p> <p>25.2 The Employer shall download the e-submitted Technical Bid. The e-GP system allows the Employer to download the e-submitted technical bid only after bid opening date and time after login simultaneously by at least two members of the Bid Opening Committee.</p> <p>25.3 Electronically submitted Technical Bid shall be opened at first in the same time and date as specified above. Electronic Bids shall be opened one by one and read out. The e-submitted technical bids must be readable through open standards interfaces. Unreadable and or partially submitted bid files shall be considered incomplete.</p> <p>25.4 Thereafter, envelopes marked "WITHDRAWAL" shall be opened and read out and the envelope with the corresponding Bid shall not be opened, but returned to the Bidder. No bid withdrawal shall be Permitted unless the corresponding withdrawal notice contains a valid authorization to request the withdrawal and is read out at bid opening. Next, envelopes marked "MODIFICATION" shall be opened and read out with the corresponding bid. No Technical Bid and/or Price Bid modification shall be permitted unless the corresponding modification notice contains a valid authorization to request the modification and is read out and recorded at bid opening. Only the Technical Bid, both Original as well as Modification, are to be opened, read out, and recorded at the opening. Price Bids, both Original and Modification, will remain unopened in accordance with ITB 25.1.</p> <p>25.5 All other envelopes holding the Technical Bid shall be opened one at a time, reading out: the name of the Bidder; whether there is a modification; the presence of a bid security and any other details as the Employer may consider appropriate.</p> <p>Only Technical Bids read out and recorded at bid opening shall be</p>

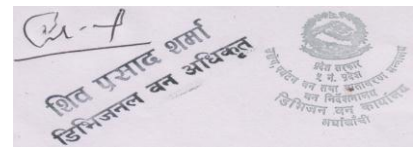

	<p>considered for evaluation.</p> <p>No bid shall be rejected at opening of Technical Bids except for late bids, in accordance with ITB 23.1.</p>
	<p>25.6 The Employer shall prepare a record of the opening of Technical Bids that shall include, as a minimum: the name of the Bidder and whether there is a withdrawal, or modification; and the presence or absence of a bid security. The Bidders' representatives who are present shall be requested to sign the record. The omission of a Bidder's signature on the record shall not invalidate the contents and effect of the record.</p>
	<p>25.7 At the end of the evaluation of the Technical Bids, the Employer will invite bidders who have submitted substantially responsive Technical Bids and who have been determined as being qualified for award to attend the opening of the Price Bids. The date, time, and location of the opening of Price Bids will be advised in writing by the Employer. Bidders shall be given at least 7 days notice for the opening of Price Bids.</p>
	<p>25.8 The Employer will notify Bidders in writing who have been rejected on the grounds of their Technical Bids being substantially nonresponsive to the requirements of the Bidding Document and return their Price Bids unopened.</p>
	<p>25.9 The Employer shall conduct the opening of Price Bids of all Bidders who submitted substantially responsive Technical Bids, in the presence of Bidders' representatives who choose to attend at the address, on the date, and time specified by the Employer. The Bidder's representatives who are present shall be requested to sign a register evidencing their attendance.</p>
	<p>25.10 All envelopes containing Price Bids shall be opened one at a time and the following read out and recorded:</p> <ul style="list-style-type: none">(a) the name of the Bidder;(b) whether there is a modification;(c) the Bid Prices, including any discounts and alternative offers; and(d) any other details as the Employer may consider appropriate. <p>Only Price Bids, discounts, modifications, and alternative offers read out and recorded during the opening of Price Bids shall be considered for evaluation. No Bid shall be rejected at the opening of Price Bids.</p>
	<p>25.11 The Employer shall prepare a record of the opening of Price Bids that shall include, as a minimum, the name of the Bidder, the Bid Price (per lot if applicable), any discounts, modifications and alternative offers. The Bidders' representatives who are present shall be requested to sign the record. The omission of a Bidder's signature on the record shall not invalidate the contents and effect of the record.</p>

E. Evaluation and Comparison of Bids	
26. Confidentiality	26.1 Information relating to the examination, evaluation, comparison, and post-qualification of bids and recommendation of Contract award, shall not be disclosed to Bidders or any other persons not officially concerned with such process until information on Contract award is communicated to all Bidders.
	26.2 Any attempt by a Bidder to influence the Employer in the evaluation of the bids or Contract award decisions may result in the rejection of its bid.
	26.3 Notwithstanding ITB 26.2, from the time of bid opening to the time of Contract award, if any Bidder wishes to contact the Employer on any matter related to the bidding process, it may do so in writing.
27. Clarification of Bids	27.1 To assist in the examination, evaluation, and comparison of the Technical and Price Bids, the Employer may, at its discretion, ask any Bidder for a clarification of its Bid. Any clarification submitted by a Bidder that is not in response to a request by the Employer shall not be considered. The Employer's request for clarification and the response shall be in writing. No change in the substance of the Technical Bid or prices in the Price Bid shall be sought, offered, or permitted, except to confirm the correction of arithmetic errors discovered by the Employer in the evaluation of the Price Bids, in accordance with ITB 33. In case of e-submission of bid, upon notification from the employer, the bidder shall also submit the original of documents comprising the Technical and Price Bid as per ITB 11.2 and ITB 11.3 for verification of submitted documents for acceptance of the e-submitted bid.
	27.2 If a Bidder does not provide clarifications of its Bid by the date and time set in the Employer's request for clarification, its Bid may be rejected.
28. Deviations, Reservations, and Omissions	28.1 During the evaluation of bids, the following definitions apply: <ul style="list-style-type: none"> (a) "Deviation" is a departure from the requirements specified in the Bidding Document; (b) "Reservation" is the setting of limiting conditions or withholding from complete acceptance of the requirements specified in the Bidding Document; and (c) "Omission" is the failure to submit part or all of the information or documentation required in the Bidding Document.
29. Examination of Technical Bid	29.1 The Employer shall examine the Technical Bid to confirm that all documents and technical documentation requested in ITB 11.2 have been provided, and to determine the completeness of each document submitted.
	29.2 The Employer shall confirm that the following documents and information have been provided in the Technical Bid. If any of these documents or information is missing, the offer shall be rejected.

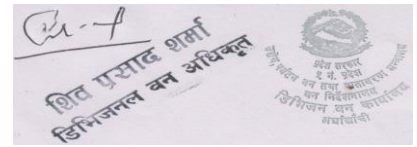

	<p>(a) Letter of Technical Bid;</p> <p>(b) written confirmation of authorization to commit the Bidder;</p> <p>(c) Bid Security; and</p> <p>(d) Technical Proposal in accordance with ITB 16</p>
<p>30. Determination of Responsiveness of Technical Bid</p>	<p>30.1 The Employer's determination of a Bid's responsiveness is to be based on the contents of the bid itself, as defined in ITB11.2.</p>
	<p>30.2 A substantially responsive Technical Bid is one that meets the requirements of the Bidding Document without material deviation, reservation, or omission. A material deviation, reservation, or omission is one that,</p> <p>(a) if accepted, would:</p> <p>(i) affect in any substantial way the scope, quality, or performance of the Works specified in the Contract;</p> <p>or</p> <p>(ii) limit in any substantial way, inconsistent with the Bidding Document, the Employer's rights or the Bidder's obligations under the proposed Contract; or</p> <p>(b) if rectified, would unfairly affect the competitive position of other Bidders presenting substantially responsive bids.</p>
	<p>30.3 The Employer shall examine the technical aspects of the Bid submitted in accordance with ITB 16, Technical Proposal, in particular, to confirm that all requirements of Section VI (Works Requirements) have been met without any material deviation, reservation or omission.</p>
	<p>30.4 If a bid is not substantially responsive to the requirements of the Bidding Document, it shall be rejected by the Employer and may not subsequently be made responsive by correction of the material deviation, reservation, or omission.</p>
	<p>30.5 In case of e-submission bids, the Employer evaluates the bid on the basis of the information in the electronically submitted bid files. If the Bidder cannot substantiate or provide evidence to establish the information provided in e-submitted bid through documents/clarifications as per ITB Clause 27.1, the bid shall not be considered for further evaluation.</p>
	<p>30.6 In Case, a corruption case is being filed to Court against the Natural Person or Board of Director of the firm/institution /company or any</p>

	<p>partner of JV, such Natural Person or Board of Director of the firm/institution /company or any partner of JV such bidder's bid shall be excluded from the evaluation, if public entity receives instruction from Government of Nepal.</p> <p>30.7 Except in case of e-submission, the Financial Bid of the bidder, which is evaluated as substantially non-responsive in technical bid, shall be returned to the respective bidders.</p>
<p>31. Nonconformities Errors, and Omissions</p>	<p>31.1 Provided that a bid is substantially responsive, the Employer may waive any non-conformities in the bid that do not constitute a material deviation, reservation, or omission.</p> <p>31.2 Provided that a Technical Bid is substantially responsive, the Employer may request that the Bidder submit the necessary information or documentation, within a reasonable period of time, to rectify nonmaterial nonconformities in the Technical Bid related to documentation requirements. Requesting information or documentation on such nonconformities shall not be related to any aspect of the Price Bid. Failure of the Bidder to comply with the request may result in the rejection of its bid.</p> <p>31.3 Provided that a Technical Bid is substantially responsive, the Employer shall rectify quantifiable nonmaterial nonconformities related to the Bid Price. To this effect, the Bid Price shall be adjusted, for comparison purposes only, to reflect the price of a missing or non-conforming item or component. The adjustment shall be made using the methods indicated in Section III (Evaluation and Qualification Criteria).</p> <p>31.4 If the monetary value of such non-conformities is found to be more than fifteen percent of the Bid Price of the bidder pursuant to ITB 31.3, such bid shall be considered nonresponsive and shall not be involved in evaluation.</p>
<p>32 Qualification of the Bidder</p>	<p>32.1 The Employer shall determine to its satisfaction during the evaluation of Technical Bids whether Bidders meet the qualifying criteria specified in Section III (Evaluation and Qualification Criteria).</p> <p>32.2 The determination shall be based upon an examination of the documentary evidence of the Bidder's qualifications submitted by the Bidder, pursuant to ITB 17.1.</p> <p>32.3 An affirmative determination shall be a prerequisite for the opening and evaluation of a Bidder's Price Bid. A negative determination shall result into the disqualification of the Bid, in which event the Employer shall return the unopened Price Bid to the Bidder.</p>
<p>33. Correction of Arithmetical Errors</p>	<p>33.1 During the evaluation of Price Bids, the Employer shall correct arithmetical errors on the following basis:</p> <p>(a) only for unit price Contracts, if there is a discrepancy between the unit price and the total price that is obtained by multiplying the unit price and quantity, the unit price shall prevail and the total price shall be corrected, unless in the opinion of the Employer there is an obvious misplacement of the decimal point in the unit price, in</p>

	<p>which case the total price as quoted shall govern and the unit price shall be corrected;</p> <p>(b) if there is an error in a total corresponding to the addition or subtraction of subtotals, the subtotals shall prevail and the total shall be corrected;</p> <p>(c) If there is a discrepancy between the bid price in the Summary of Bill of Quantities and the bid amount in item (c) of the Letter of Price Bid, the bid price in the Summary of Bill of Quantities will prevail and the bid amount in item (c) of the Letter of Price Bid will be corrected.</p> <p>(d) if there is a discrepancy between words and figures, the amount in words shall prevail, unless the amount expressed in words is related to an arithmetic error, in which case the amount in figures shall prevail subject to (a), (b) and (c) above.</p> <p>33.2 If the Bidder that submitted the lowest evaluated bid does not accept the correction of errors, its bid shall be disqualified and its bid security shall be forfeited.</p>
34 Subcontractors	<p>34.1 In case of Prequalification, the Bidder's Bid shall name the same subcontractor as submitted in the prequalification application and approved by the Employer.</p> <p>In case of Post-qualification, the Employer may permit subcontracting for certain specialized works as indicated in Section III When subcontracting is permitted by the Employer, the sub-contractor shall meet the qualifications criteria as indicated in section III.</p> <p>Sub-contractors' qualification and experience will not be considered for evaluation of the Bidder. The Bidder on its own (without taking into account the qualification and experience of the sub-contractor) should meet the qualification criteria.</p> <p>Bidders may propose subcontracting up to the percentage of total value of contracts or the volume of works as specified in the BDS.</p>
35. Evaluation of Price Bids	<p>35.1 The Employer shall use the criteria and methodologies listed in this Clause. No other evaluation criteria or methodologies shall be permitted.</p> <p>35.2 To evaluate a Price Bid, the Employer shall consider the following:</p> <p>(a) the bid price, excluding Value Added Tax , Provisional Sums, and the provision, if any, for contingencies in the Summary Bill of Quantities, for Unit Rate Contracts, or Schedule of Prices for lump sum Contracts, but including Day work items, where priced competitively;</p> <p>(b) price adjustment for correction of arithmetic errors in accordance with ITB 33.1;</p> <p>(c) price adjustment due to discounts offered in accordance with ITB 14.4;</p> <p>(d) adjustment for nonconformities in accordance with ITB 31.3;</p> <p>(e) application of all the evaluation factors indicated in Section III (Evaluation</p>

	and Qualification Criteria);
	35.3 The estimated effect of the price adjustment provisions of the Conditions of Contract, applied over the period of execution of the Contract, shall not be taken into account in bid evaluation.
	35.4 If this Bidding Document allows Bidders to quote separate prices for different Contracts, and to award multiple Contracts to a single Bidder, the methodology to determine the lowest evaluated price of the Contract combinations, including any discounts offered in the Letter of Price Bid, is specified in Section III (Evaluation and Qualification Criteria).
	35.5 if the bid for an Unit Rate Contract, which results in the lowest Evaluated Bid Price is seriously unbalanced or front loaded or extremely low in the opinion of the Employer, the Employer may require the Bidder to produce detailed price analysis for any or all items of the Bill of Quantities, to demonstrate the internal consistency of those prices with the construction methods and schedule proposed. After evaluation of the price analysis, taking into consideration the schedule of estimated Contract payments, the Employer may require that the amount of the performance security be increased at the expense of the Bidder as mentioned in BDS to protect the Employer against financial loss in the event of default of the successful Bidder under the Contract or may consider the bid as non-responsive .
	35.6 In case of e-submission bids, the Employer evaluates the bid on the basis of the information in the electronically submitted bid files. If the Bidder cannot substantiate or provide evidence to establish the information provided in e-submitted bid through documents/clarifications as per ITB Clause 27.1, the bid shall not be considered for further evaluation.
	35.7 In Case, a corruption case is being filed to Court against the Natural Person or Board of Director of the firm/institution /company or any partner of JV, such Natural Person or Board of Director of the firm/institution /company or any partner of JV such bidder's bid shall be excluded from the evaluation, if public entity receives instruction from Government of Nepal.
36. Comparison of Bids	36.1 The Employer shall compare all substantially responsive bids in accordance with ITB 35.2 to determine the lowest evaluated bid.
37. Employer's Right to Accept Any Bid, and to Reject Any or All Bids	37.1 The Employer reserves the right to accept or reject any bid, and to annul the bidding process and reject all Bids at any time prior to contract award, without thereby incurring any liability to Bidders. In case of annulment, all Bids submitted and specifically, bid securities, shall be promptly returned to the Bidders.
F. Award of Contract	

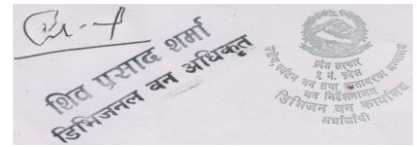

38. Award Criteria	38.1 The Employer shall award the Contract to the Bidder whose offer has been determined to be the lowest evaluated bid and is substantially responsive to the Bidding Document, provided further that the Bidder is determined to be qualified to perform the Contract satisfactorily.
39. Letter of Intent to Award the Contract/Notification of Award	39.1 The Employer shall notify the concerned Bidder whose bid has been selected in accordance with ITB 38.1 within seven days of the selection of the bid, in writing that the Employer has intention to accept its bid and the information regarding the name, address and amount of selected bidder shall be given to all other bidders who submitted the bid.
	39.2 If no bidder submits an application pursuant to ITB 42 within a period of seven days of the notice provided under ITB 39.1, the Employer shall, accept the bid selected in accordance with ITB 38.1 and Letter of Acceptance shall be communicated to the selected bidder prior to the expiration of period of Bid validity, to furnish the performance security and sign the contract within fifteen days.
	39.3 In Case, a corruption case is being filed to Court against the Natural Person or Board of Director of the firm/institution /company or any partner of JV, such Natural Person or Board of Director of the firm/institution /company or any partner of JV such bidder's bid shall be excluded from the evaluation, if public entity receives instruction from Government of Nepal.
40. Performance Security	<p>40.1 Within Fifteen (15) days of the receipt of Letter of Acceptance from the Employer, the successful Bidder shall furnish the performance security in accordance with the Conditions of Contract, subject to ITB 35.5, as specified below from Commercial Bank or Financial Institution eligible to issue Bank Guarantee as per prevailing Law in Nepal using Sample Form for the Performance Security included in Section X (Contract Forms), or another form acceptable to the Employer. The performance security issued by any foreign Bank outside Nepal must be counter guaranteed by Commercial Bank or Financial Institution eligible to issue Bank Guarantee as per prevailing Law in Nepal.</p> <p>i) If bid price of the bidder selected for acceptance is up to 15 (fifteen) percent below the approved cost estimate, the performance security amount shall be 5 (five) percent of the bid price.</p> <p>ii) For the bid price of the bidder selected for acceptance is more than 15 (fifteen) percent below of the cost estimate, the performance security amount shall be determined as follows:</p> <p>Performance Security Amount = [(0.85 x Cost Estimate – Bid Price) x 0.5] + 5% of Bid Price.</p> <p>The Bid Price and Cost Estimate shall be inclusive of Value Added Tax.</p>
	40.2 Failure of the successful Bidder to submit the above-mentioned Performance Security or to sign the Contract Agreement shall constitute sufficient grounds for the annulment of the award and forfeiture of the bid security. In that event the Employer may award the Contract to the next lowest evaluated Bidder whose offer is

	substantially responsive and is determined by the Employer to be qualified to perform the Contract satisfactorily. The process shall be repeated according to ITB 39.
41 Signing of Contract	41.1 The Employer and the successful Bidder shall sign the Contract Agreement within the period as stated ITB 40.1.
	41.2 At the same time, the Employer shall affix a public notice on the result of the award on its notice board and make arrangement for causing such notice to be affixed on the notice board also of the District Coordination Committee, District Administration Office, Provincial Treasury and Controller Office and District Treasury and Controller Office . The Employer may make arrangements to post the notice into its website, if it has; and if it does not have, into the website of the Public Procurement Monitoring Office, identifying the bid and lot numbers and the following information: (i) the result of evaluation of bid; (ii) date of publication of notice inviting bids; (iii) name of newspaper; (iv) reference number of notice; (v) item of procurement; (vi) name and address of bidder making contract and (viii) contract price
	41.3 Within thirty (30) days from the date of issuance of notification pursuant to ITB 39.1 unsuccessful bidders may request in writing to the Employer for a debriefing seeking explanations on the grounds on which their bids were not selected. The Employer shall promptly respond in writing to any unsuccessful Bidder who, requests for debriefing.
	41.4 If the bidder whose bid has been accepted fails to sign the contract as stated ITB 40.1, the Public Procurement Monitoring Office shall blacklist the bidder on recommendation of the Public Entity.
42. Complaint and Review	42.1 If a Bidder is dissatisfied with the Procurement proceedings or the decision made by the Employer in opening of the price bid or the intention to award the Contract, it may file an application to the Chief of the Public Entity or Public Procurement Monitoring Office or office established as per Clause 145(a) of the Public Procurement Regulation within Seven (7) days of providing the notice under ITB 25.8 and ITB 39.1 by the Public Entity, for review of the proceedings stating the factual and legal grounds.
	42.2 Late application filed after the deadline pursuant to ITB 42.1 shall not be processed.
	42.3 The chief of Public Entity shall, within five (5) days after receiving the application, give its decision with reasons, in writing pursuant to ITB 42.1: <ul style="list-style-type: none"> (a) whether to suspend the procurement proceeding and indicate the procedure to be adopted for further proceedings; or (b) to reject the application. <p>The decision of the chief of Public Entity shall be final for the Bid amount up to the value as stated in 42.4.</p>
	42.4 If the Bidder is not satisfied with the decision of the Public Entity in

	<p>accordance with ITB 42.3, is not given within five (5) days of receipt of application pursuant to ITB 42.1, it can, within seven (7) days of receipt of such decision, file an application to the Review Committee of the GoN, stating the reason of its disagreement on the decision of the chief of Public Entity and furnishing the relevant documents, provided that its Bid amount ,equal or more than Rupees Six Million (NRs. 6,000,000). The application may be sent by hand, by post, by courier, or by electronic media at the risk of the Bidder itself.</p>
	<p>42.5 Late application filed after the deadline pursuant to ITB 42.4 shall not be processed.</p>
	<p>42.6 Within three (3) days of the receipt of application from the Bidder, pursuant to ITB 42.4, the Review Committee shall notify the concerning Public Entity to furnish its procurement proceedings, pursuant to ITB 42.3.</p>
	<p>42.7 Within three (3) days of receipt of the notification pursuant to ITB 42.6, the Public Entity shall furnish the copy of the related documents to the Review Committee.</p>
	<p>42.8 The Review Committee, after inquiring from the Bidder and the Public Entity, if needed, shall give its decision within one (1) month of the receipt of the application filed by the Bidder, pursuant to ITB 42.4.</p>
	<p>42.9 The Bidder, filing application pursuant to ITB 42.4, shall have to furnish a cash amount or Bank guarantee from Commercial Bank or Financial Institution eligible to issue Bank Guarantee as per prevailing Law equivalent to zero point one percent (0.10%) of its quoted Bid amount with the validity period of at least ninety (90) days from the date of the filing of application pursuant to ITB 42.4.</p>
	<p>42.10 If the claim made by the Bidder pursuant to ITB 42.4 is justified, the Review Committee shall have to return the security deposit to the applicant, pursuant to ITB 42.9, within seven (7) days of such decision made.</p>

Section II: Bid Data Sheet

A. General	
ITB 1.1	The number of the Invitation for Bids is: DFO/W/03/076/77
ITB 1.1	The Employer is: Division Forest Office, Arghakhanchi
ITB 1.1	The number and identification of lots comprising this bidding process is:
ITB 2.1	The name of the Project is Tourism Infrastructure Construction At Panini Tapobhumi The DP is N/A The implementing agency is Division Forest Office, Arghakhanchi GoN Funded
ITB 3.3 (d)	For DP Funded: N/A
ITB 4.1 (a)	For GoN Funded: Maximum number of partner in a joint venture shall be : 3 (three)
ITB 4.4	For DP: N/A
B. Bidding Document	
ITB 7.1	For clarification purposes only, the Employer's address is: Attention: Division Forest Office, Arghakhanchi Address: Sandhikharka, Arghakhanchi Telephone: : 077420109 Facsimile number: _____ Electronic mail address: dfoarghakhanchi@gmail.com
ITB 7.4	A Pre-Bid meeting shall not be held.
ITB 7.5	Time for request: Requests for clarification should be received by the Employer no later than 10 days prior to the deadline for submission of bids.
C. Preparation of Bids	
ITB 10.1	The language of the bid is: English / Nepali
ITB 11.2 (h)	The Bidder shall submit with its Technical Bid the following additional documents: Work Methodology,

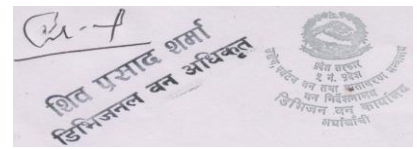

ITB 11.3 (b)	In accordance with ITB 12 and ITB 14, the following schedules shall be submitted with the bid, including the priced Bill of Quantities for Unit Rate Contracts and Schedule of Prices for lump sum contracts.
11.3 (d)	The Bidder shall submit with its Price Bid the following additional document:N/A
ITB 13.1	Alternative bids shall not be permitted.
ITB 13.2	Alternative times for completion shall not be permitted. <i>If alternative times for completion are permitted, the evaluation method will be as specified in Section III (Evaluation and Qualification Criteria).</i>
ITB 13.4	Alternative technical solutions shall be permitted for the following parts of the Works: <i>If alternative technical solutions are permitted, the evaluation method will be as specified in Section III (Evaluation and Qualification Criteria).</i>
ITB 14.6	The prices quoted by the Bidder shall not be subject to adjustment during the performance of the Contract.
ITB 18.1	The bid validity period shall be: 90 days
ITB 19.1	The Bidder shall furnish a bid security, from Commercial Bank or Financial Institution eligible to issue Bank Guarantee as per prevailing Law with a minimum of NRs. 771090.26 which shall be valid for 30 days beyond the validity period of the bid.
ITB 19.2 (b)	Office Name: Division Forest Office, Arghakhanchi Bank Name : Rastriya Banijya Bank Bank Address: Sandhikharka Account Number: 1000200010000 Office Code: 3070251015
ITB 20.1	In addition to the original of the bid, the number of copy/ies is/are: NA
ITB 20.2	The written confirmation of authorization to sign on behalf of the Bidder shall indicate: (a) The name and description of the documentation required to demonstrate the authority of the signatory to sign the Bid such as a Power of Attorney; and (b) In the case of Bids submitted by an existing or intended JV, an undertaking signed by all parties (i) stating that all parties shall be jointly and severally liable, and (ii) nominating a Representative who shall have the authority to conduct all business for and on behalf of any and all the parties of the JV during the bidding process and, in the event the JV is awarded the Contract, during contract execution.
D. Submission and Opening of Bids	
ITB 21.1	Bidders shall have the option of submitting their bids by electronic only
ITB 22.1	For bid submission purposes only, the Employer's address is : Attention : Division Forest office, Arghakhanchi

	Address : Sandhikharka, Arghakhanchi The deadline for bid submission is : Date : 03-03-2020 Time : 17:00 Hrs
ITB 25.1	The Technical Bid opening shall take place at : Address : Division Forest office, Arghakhanchi Date : 04-03-2020 Time : 12:00 Hrs
E. Evaluation and Comparison of Bids	
ITB 34.1	a) Contractor's proposed subcontracting: Maximum percentage of subcontracting permitted is: 25% of the total contract amount. b) Sub-contractors' qualification and experience will not be considered for evaluation of the Bidder. The Bidder on its own (without taking into account the qualification and experience of the sub-contractor) should meet the qualification criteria.
ITB 35.5	The amount of the performance security be increased by Eight (8) percent of the quoted bid price.
ITB 41.4	For DP Funded: Not Applicable

Section III: Evaluation and Qualification Criteria

This Section contains all the criteria that the Employer shall use to evaluate bids and qualify Bidders by post-qualification exercise. GoN/DP requires bidders to be qualified by meeting predefined, precise minimum requirements. The method sets pass-fail criteria, which, if not met by the bidder, results in disqualification. In accordance with ITB 32 and ITB 35, no other methods, criteria and factors shall be used. The Bidder shall provide all the information requested in the forms included in Section IV (Bidding Forms).

1. Evaluation

In addition to the criteria listed in ITB 35.2 (a) - (e) the following criteria shall apply:

Note:

Use the evaluation criteria listed below as appropriate and required for the project.

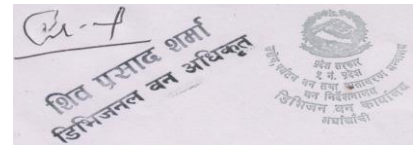

1.1 Adequacy of Technical Proposal

Evaluation of the Bidder's Technical Proposal will include an assessment of the Bidder's technical capacity, to mobilize key equipment and personnel for the contract consistent with its proposal regarding work methods, scheduling, and material sourcing in sufficient detail and fully in accordance with the requirements stipulated in Section VI (Works Requirements).

1.2 Multiple Contracts

Pursuant to Sub-Clause 35.4 of the Instructions to Bidders, if Works are grouped in multiple contracts, evaluation will be as follows:

Works are grouped in multiple contracts and pursuant to Sub-Clause 35.4 of the Instructions to Bidders, the Employer will evaluate and compare Bids on the basis of a contract, or a combination of contracts, or as a total of contracts in order to arrive at the least cost combination for the Employer by taking into account discounts offered by Bidders in case of award of multiple contracts.

If a bidder submits several successful (lowest evaluated substantially responsive) bids, the evaluation will also include an assessment of the Bidder's capacity to meet the aggregated requirements regarding:

- Specific Construction Experience
- Average Annual Construction Turnover
- Financial Resources

1.3 Completion Time

An alternative Completion Time, if permitted under ITB 13.2, will be evaluated as follows:

N/A

1.4 Alternative Technical Solutions

Alternative technical solutions, if permitted under ITB 13.4, will be evaluated as follows:

N/A

1.5 Quantifiable Nonconformities and Omissions

Subject to ITB 14.2 and ITB 35.2, the evaluated cost of quantifiable nonconformities including omissions, is determined as follows:

“Pursuant to ITB 31.3, the cost of all quantifiable nonmaterial nonconformities shall be evaluated, but excluding omission of prices in the Bill of Quantities. The Employer will make its own assessment of the cost of any nonmaterial nonconformities and omissions for the purpose of ensuring fair comparison of bids.”]

2. Qualification

2.1 Eligibility

Criteria		Compliance Requirements			Documents
Requirement	Single Entity	Joint Venture			Submission Requirements
		All Partners Combined	Each Partner	One Partner	
2.1.1 Nationality					
Nationality in accordance with ITB sub-clause 4.2	must meet requirement	must meet requirement	must meet requirement	not applicable	Letter of Technical Bid Forms ELI -1; ELI -2 with attachments
2.1.2 Conflict of Interest					
No conflicts of interest in accordance with ITB Sub-Clause 4.3.	must meet requirement	existing or intended JV must meet requirement	must meet requirement	not applicable	Letter of Technical Bid
2.1.3 Government/DP Eligibility					
Not having been declared ineligible by government/DP, as described in ITB Sub-Clause 4.4.	must meet requirement	must meet requirement	must meet requirement	not applicable	Letter of Technical Bid
2.1.4 Government-owned Entity					
Bidder required to meet conditions of ITB Sub-Clause 4.5.	must meet requirement	existing or intended JV must meet requirement	must meet requirement	not applicable	Forms ELI - 1, ELI - 2, with attachments
2.1.5 UN Eligibility					
Not having been declared ineligible based on a United Nations resolution or Employer's country law, as described in ITB Sub-Clause 4.8.	must meet requirement	existing or intended JV must meet requirement	must meet requirement	not applicable	Letter of Technical Bid

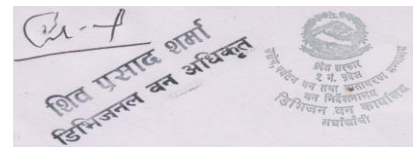

2.1.6 Other Eligibility					
Firm Registration Certificate	must meet requirement	not applicable	must meet requirement	not applicable	Document attachment
Business Registration Certificate	must meet requirement	not applicable	must meet requirement	not applicable	Document attachment
VAT and PAN Registration certificate (<i>only for domestic bidders</i>)	must meet requirement	not applicable	must meet requirement	not applicable	Document attachment
Tax Clearance Certificate/Tax return submission evidence/evidence of time extension for the F/Y(<i>Only for domestic bidders</i>)	must meet requirement	not applicable	must meet requirement	not applicable	Document attachment

2.2 Pending Litigation

Criteria		Compliance Requirements			Documents
Requirement	Single Entity	Joint Venture			Submission Requirements
		All Partners Combined	Each Partner	One Partner	
2.2.1 Pending Litigation					
All pending litigation shall be treated as resolved against the Bidder and so shall in total not represent more than 75percent of the Bidder's net worth.	must meet requirement by itself or as partner to past or existing JV	not applicable	must meet requirement by itself or as partner to past or existing JV	not applicable	Form LIT - 1

Note:

- (1) The percentage should normally be within the range of 50% to 100% of the Bidder's net worth.

2.3 Financial Situation

Criteria		Compliance Requirements			Documents
Requirement	Single Entity	Joint Venture			Submission Requirements
		All Partners Combined	Each Partner	One Partner	
2.3.1 Historical Financial Performance					
Submission of audited balance sheets and income statements, for the last(1)..... years to demonstrate the current soundness of the Bidder's financial position. As a minimum, a Bidder's net worth calculated as the difference between total assets and total liabilities should be positive.	must meet requirement	not applicable	must meet requirement	not applicable	Form FIN - 1 with attachments

Note:

- (1) The financial information provided by a Bidder should be reviewed in its entirety to allow a truly informed judgment, and the pass-fail decision on the financial position of the Bidder should be given on this basis. Balance sheet of the past three to five years period which shall be decided according to the nature of the work.

2.3.2 Average Annual Construction Turnover					
Minimum average annual construction turnover of NRs(2)....., calculated as total certified payments received for construction contracts in progress or completed, within best three years out of last ten years.	must meet requirement	must meet requirement	must meet3..... of the requirement	must meet4..... of the requirement	Form FIN -2

Only the net amount shall be calculated after deducting the amount for VAT and such amount shall be adjusted to present value by applying wholesale price index of Nepal Rastra Bank.

Note:

- (2) The amount stated should normally not be less than $1.5 \times V/T$, the estimated annual turnover in the subject contract based on a straight-line projection of the Employer's estimated cost (V), over the contract duration (T) in year. Contract duration less than one year shall be considered one year. The multiplier of 1.5 may be reduced up to 1 (one) in accordance with the size, nature and complexity of

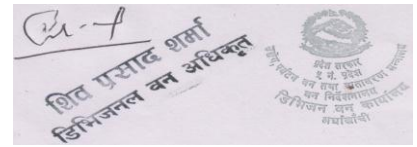

- contracts.
- (3) Usually not less than 25 %
 - (4) Usually not less than 40 %

2.3.3 Financial Resources					
Using Forms FIN - 3 and FIN - 4 in Section IV (Bidding Forms) the Bidder must demonstrate access to, or availability of, financial resources such as liquid assets, unencumbered real assets, lines of credit, and other financial means, other than any contractual advance payments to meet its current Contract Commitments, plus: <input type="checkbox"/> The following cash-flow requirement,..... (5).....	must meet requirement	must meet requirement	must meet6..... of the requirement	must meet7..... of the requirement	Form FIN - 3 and Form FIN - 4

Note:

- (5) Construction cash flow requirement for a number of months (to the nearest half-month), determined as the total time needed by the Employer to pay a contractor's invoice, allowing for (a) the actual time consumed for construction, from the beginning of the month invoiced, (b) the time needed by the Project Manager to issue the monthly payment certificate, (c) the time needed by the Employer to pay the amount certified, and (d) a contingency period of one month to allow for unforeseen delays. The total period should not exceed six months. The assessment of the monthly amount should be based on a straight-line projection of the estimated cash flow requirement over the particular contract period, neglecting the effect of any advance payment and retention monies, but including contingency allowances in the estimated contract cost.
- (6) Usually not less than 25 %
- (7) Usually not less than 40 %

2.4 Experience

Criteria		Compliance Requirements			Documents
Requirement	Single Entity	Joint Venture			Submission Requirement
		All Partners Combined	Each Partner	One Partner	
2.4.1 General Construction Experience					
Experience under construction contracts in the role of contractor, subcontractor, or management contractor for at least the last 3 years prior to the applications submission deadline.	must meet requirement	not applicable	must meet requirement	not applicable	Form EXP - 1

Note:

2.4.2 Specific Construction Experience					
(a) Contracts of Similar Size and Nature					
Participation as Prime contractor, management contractor, or subcontractor, in at least 3 Contracts within the last ten (10) years, each with a value of at least NRs 27000000 that have been successfully or are substantially completed and that are similar to the proposed works. The similarity shall be based on the physical size, complexity, methods, technology or other characteristics as described in Section VI, Works Requirements.	must meet requirement	must meet requirement	not applicable	not applicable	Form EXP – 2(a)

Only the net amount shall be calculated after deducting the amount for VAT and such amount shall be adjusted to present value by applying wholesale price index of Nepal Rastra Bank.

Note:

- (2) Insert number of contracts, the range should be one to two, depending on the size and complexity of the subject contract, the exposure of the risk to the Employer by contractor's default.
- (3) Insert amount in Nepalese rupees, which is usually 80% of the estimated value of the subject contract.

(b) Construction Experience in Key Activities
--

<p>For the above or other contracts executed during the period stipulated in 2.4.2(a) above, a minimum construction experience in the following key activities :</p> <p><i>[list activities indicating volume, number or rate of production as applicable; for the key activity (ies) in the subject contract. The rates should be about 80% of the estimated production rates of the key activity(ies) in the subject contract as needed to meet the expected construction schedule with due allowance for adverse climatic conditions.]</i></p>	<p>must meet all requirements</p>	<p>must meet all requirements</p>	<p>not applicable</p>	<p>not applicable</p>	<p>Form EXP - 2(b)</p>

2.5 Personnel

The Bidder must demonstrate that it has the personnel for the key positions that meet the following requirements:

SN.	Position	Required No.	Academic Qualification [When position demands]	Total Work Experience [Years]	Experience in Similar Works [years]
1.					
2.					
3.					
4.					
5.					

In case the bidder proposes to consider Personnel that may be spared from committed/ongoing contracts for evaluation, the bidder shall provide details of personnel which will be spared from such committed/ongoing contracts based on the physical progress at the date of bid submission.

The Bidder shall provide details of the proposed personnel and their experience records in the relevant Information Forms included in Section IV (Bidding Forms).

Note:

The managerial and technical competence of a contractor is largely related to the key personnel on site. The extent to which the Bidder should demonstrate having staff with extensive experience should be limited to those requiring critical operational or technical skills. The qualification criteria should therefore refer to a limited number of such key personnel, for instance, the project or contract manager and those superintendents working under the project manager who will be responsible for major components (e.g., superintendents specialized in dredging, piling, tunneling, or earthworks, as required for each particular project).

Criteria of acceptability should be based on:

- a minimum number of years of experience in a similar position; and
- a minimum number of years of experience and/or number of comparable projects carried out in a specified number of preceding years.
- minimum education qualification only in case the position requires. It is appropriate to specify that certain positions are filled by individuals who have held posts of comparable authority for, say, three years with the Bidder, so that key staff in executive site positions have sufficient knowledge of the Bidder's management, policy, procedures, and practices to act with confidence and authority within that framework.

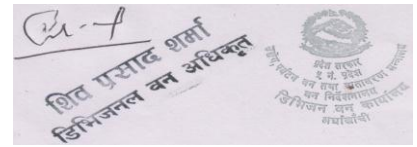

2.6 Equipment

The Bidder must demonstrate that it has the key equipment listed hereafter:

No.	Equipment Type and Characteristics	Min. Number Requirement
1.		
2.		
3.		
4.		
5.		

In case the Bidder proposes to consider Equipment that may be spared from committed/ongoing contracts for evaluation, the Bidder shall provide details of Equipment which will be spared from committed / ongoing contracts clearly demonstrating the availability of such equipment with respect to the physical progress of the ongoing contracts on the date of bid submission.

In case of Equipment to be leased/hired the same procedure as mentioned above shall apply.

The Bidder shall provide further details of proposed items of equipment using the relevant Form in Section IV (Bidding Forms)

Note:

An inventory of construction equipment represents a high capital cost overhead to a contractor. Consequently, not all competent potential bidders will maintain an inventory of high-value items that are in suitable condition for major contracts. This is particularly so with management contractors, who undertake construction projects mainly by subcontracting. In most cases Bidders can readily purchase, lease, or hire equipment; thus, it is usually unnecessary for the assessment of a contractor's qualification to depend on the contractor's owning readily available items of equipment. The pass-fail criteria adopted should therefore be limited only to those bulky or specialized items that are critical for the type of project to be implemented, and that may be difficult for the contractor to obtain quickly. Examples may include items such as heavy lift cranes and piling barges, dredgers, tunnel boring machines, asphalt mixing plants, etc. Even in such cases, contractors may not own the specialized items of equipment, and may rely on specialist subcontractors or equipment-hire firms. The availability of such subcontractors and of the specified equipment should be subject to verification prior to contract award. The terms of any lease or hire agreement for equipment should preferably include provision that the equipment will remain on the site (or be vested in the Employer) in the event of default of the Contractor, thereby ensuring more timely continuity of work by a replacement contractor

2.7 Subcontractors

N/A

Note: Employer should specify the nature of work, if sub-contracting is permitted.

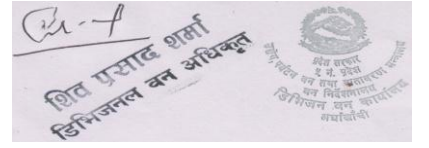

Section IV: Bidding Forms

This Section contains the forms which are to be completed by the Bidder and submitted as part of its Bid.

Letter of Technical Bid

The Bidder must accomplish the Letter of Bid in its letterhead clearly showing the Bidder's complete name and address.

Date:

Name of the contract:

Invitation for Bid No.:

To:.....

We, the undersigned, declare that:

- (a) We have examined and have no reservations to the Bidding Documents, including Addenda issued in accordance with Instructions to Bidders (ITB) Clause 8.
- (b) We offer to execute in conformity with the Bidding Documents the following Works:
- (c) Our Bid consisting of the Technical Bid and the Price Bid shall be valid for a period of **[insert validity period as specified in ITB 18.1 of the BDS]** days from the date fixed for the bid submission deadline in accordance with the Bidding Documents, and it shall remain binding upon us and may be accepted at any time before the expiration of that period.
- (d) Our firm, including any subcontractors or suppliers for any part of the Contract, have nationalities from eligible countries in accordance with ITB 4.2 **and meet the requirements of ITB 3.4, & 3.5.**
- (e) We are not participating, as a Bidder or as a subcontractor, in more than one Bid in this bidding process in accordance with ITB 4.3(e), other than alternative offers submitted in accordance with ITB 13.
- (f) Our firm, its affiliates or subsidiaries, including any Subcontractors or Suppliers for any part of the contract, has not been declared ineligible by DP, under the Employer's country laws or official regulations or by an act of compliance with a decision of the United Nations Security Council;
- (g) We are not a government owned entity/We are a government owned entity but meet the requirements of ITB 4.5;¹
- (h) We declare that, we including any subcontractors or suppliers for any part of the contract do not have any conflict of interest in accordance with ITB 4.3 and we have not been punished for an offense relating to the concerned profession or business.
- (i) We declare that we are solely responsible for the authenticity of the documents submitted by us. **The document and information submitted by us are true and correct. If any document/information given is found to be concealed at a later date, we shall accept any legal actions by the Employer.**
- (j)

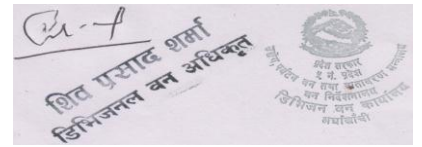

- (k) We agree to permit the Employer/DP or its representative to inspect our accounts and records and other documents relating to the bid submission and to have them audited by auditors appointed by the Employer.
- (l) If our Bid is accepted, we commit to mobilizing key equipment and personnel in accordance with the requirements set forth in Section III (Evaluation and Qualification Criteria) and our technical proposal, or as otherwise agreed with the Employer.
- (m)

Name:

In the capacity of

Signed

Duly authorized to sign the Bid for and on behalf of

Date

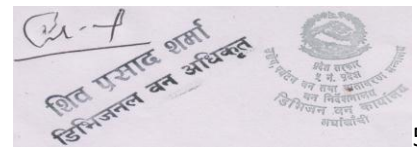

Letter of Price Bid

The Bidder must accomplish the Letter of Bid in its letterhead clearly showing the Bidder's complete name and address.

Date:

Name of the contract:

Invitation for Bid No.:

To:.....

We, the undersigned, declare that:

- (a) We have examined and have no reservations to the Bidding Documents, including Addenda issued in accordance with Instructions to Bidders (ITB) Clause 8;
- (b) We offer to execute in conformity with the Bidding Documents the following Works:
- (c) The total price of our Bid, excluding any discounts offered in item (d) below is: NRs.; or when left blank is the Bid Price indicated in the Bill of Quantities.
- (d) The discounts offered and the methodology for their application are:.....
- (e) Our bid shall be valid for a period of **[insert validity period as specified in ITB 18.1]** days from the date fixed for the bid submission deadline in accordance with the Bidding Documents, and it shall remain binding upon us and may be accepted at any time before the expiration of that period;
- (f) If our bid is accepted, we commit to obtain a performance security in accordance with the Bidding Document;
- (g) We have paid, or will pay the following commissions, gratuities, or fees with respect to the bidding process or execution of the Contract:¹

Name of Recipient	Address	Reason	Amount
.....
.....

(h) We understand that this bid, *together with your written acceptance thereof* included in your

¹ If none has been paid or is to be paid, indicate "None".

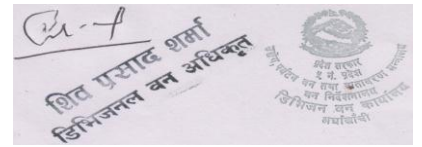

- notification of award, shall constitute a binding contract between us, until a formal contract is prepared and executed;
- (i) We understand that you are not bound to accept the lowest evaluated bid or any other bid that you may receive; and
 - (j) We declare that we are solely responsible for the authenticity of the documents submitted by us.
 - (k) We agree to permit the Employer/DP or its representative to inspect our accounts and records and other documents relating to the bid submission and to have them audited by auditors appointed by the Employer.

Name:

In the capacity of

Signed

Duly authorized to sign the Bid for and on behalf of

Date

Table of Price Adjustment Data

[To be used if Price Adjustment is applicable as per GCC 53.1]

Code	Index Description	Source of Index*	Base Value and Date	Employer's Proposed Weighting Range (coefficient)	Bidder's Proposed Weighting (coefficient)**
1	2	3	4	5	6
	Non - Adjustable (A)			0.15	0.15
	Labor (b)				
	Materials (c)				
	Equipment usage (d)				
		Total			1.00

*Normally following source of index shall apply. Public Entity shall choose applicable Index for each item.

- (a) Labor: "National Salary and Wage Rate Index" - "Construction Labor" of Nepal Rastra Bank or rate fixed by District Rate Fixation Committee
- (b) Material: "National Wholesale Price Index" - Construction Materials" of Nepal Rastra Bank
- (c) Equipment usage: "National Wholesale Price Index" - "Transport Vehicles and Machinery Goods" of Nepal Rastra Bank or "Fuel" Price fixed by Nepal Oil Corporation.

** Bidders proposed weightings should be within the range specified by the Employer in column - 5

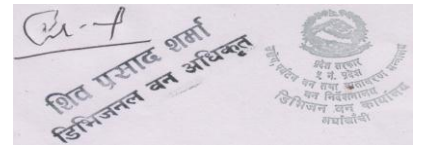

Table of Price Adjustment Data

[To be used if Price Adjustment is applicable as per GCC 53.6]

Code	Construction Material*	Unit	Base Price (NRs/Unit) (Ex-factory)	Source (Factory)**
1	2	3	4	5

* Major construction materials to be specified by Employer in column - 2.

** Base Price and source normally to be specified by Employer (or alternatively informed to be proposed by bidder) in column 4 and 5.

Note:

The base prices of the construction materials shall be taken as of 30 days before the deadline for submission of the Bid as quoted by the Bidder and verified by the Employer. For the purpose of calculation of price adjustment, the Ex-factory price of the same source shall be taken into consideration.

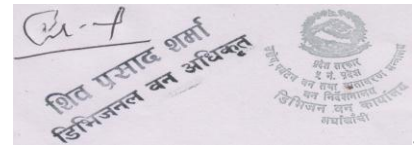

Bid Security

Bank Guarantee

Bank's Name, and Address of Issuing Branch or Office

(On Letter head of the Commercial bank or any Financial Institution eligible to issue Bank Guarantee as per prevailing Law)

Beneficiary: **name and address of Employer**

Date: Bid Security No.:

We have been informed that. **[insert name of the Bidder]** (hereinafter called "the Bidder")intends to submit its bid (hereinafter called "the Bid") to you for the execution of **name of Contract** under Invitation for Bids No. ("the IFB"). Furthermore, we understand that, according to your conditions, bids must be supported by a bid guarantee.

At the request of the Bidder, we..... **name of Bank** hereby irrevocably undertake to pay you any sum or sums not exceeding in total an amount of . . . **amount in figures** (**amount in words**) upon receipt by us of your first demand in writing accompanied by a written statement stating that the Bidder is in breach of its obligation(s) under the bid conditions, because the Bidder:

- (a) has withdrawn or modifies its Bid:
 - i) during the period of bid validity specified by the Bidder on the Letter of Technical and Price Bid, in case of electronic submission
 - (ii) from the period twenty-four hours prior to bid submission deadline up to the period of bid validity specified by the Bidder on the Letter of Technical Bid and Price Bid, in case of hard copy submission; or
- (b) does not accept the correction of errors in accordance with the Instructions to Bidders (hereinafter "the ITB"); or
- (c) changes the prices or substance of the bid while providing information pursuant to clause 27.1 of ITB; or
- (d) having been notified of the acceptance of its Bid by the Employer during the period of bid validity, (i) fails or refuses to execute the Contract Agreement, or (ii) fails or refuses to furnish the performance security, in accordance with the ITB.
- (e) is involved in fraud and corruption in accordance with the ITB

This guarantee will remain in force up to and including the date **number**.....days after the deadline for submission of Bids as such deadline is stated in the instructions to Bidders or as it may be extended by the Employer, notice of which extension(s) to the Bank is hereby waived. Any demand in respect of this guarantee should reach the Bank not later than the above date.

This Bank guarantee shall not be withdrawn or released merely upon return of the original guarantee by the Bidder unless notified by you for the release of the guarantee.

This guarantee is subject to the Uniform Rules for Demand Guarantees, ICC Publication No. 758.

...Bank's seal and authorized signature(s) ...

Note:

The bid security of has been counter guaranteed by the Bank on (Applicable for Bid Security of Foreign Banks).

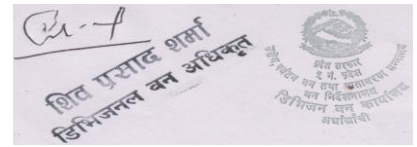

Letter of Commitment for Bank's Undertaking for Line of Credit

Bank's Name, and Address of Issuing Branch or Office
(On Letter head of the Commercial bank or any Financial Institution eligible to issue Bank Guarantee as per prevailing Law)

Invitation for Bids No:

Date:

Contract No:

Name of Contract :

To:

[Name and address of the Procuring Entity]

CREDIT COMMITMENT No: [insert number]

We have been informed that [name of Bidder] (hereinafter called "the Bidder") intends to submit to you its Bid (hereinafter called "the Bid") for the execution of the Works of **[description of works]** under the above Invitation for Bids (hereinafter called "the IFT").

Furthermore, we understand that, according to your conditions, the Bidder's Financial Capacity i.e. Liquid Asset must be substantiated by a Letter of Commitment of Bank's Undertaking for Line of Credit.

At the request of, and arrangement with, the Bidder, we [name and address of the Bank] do hereby agree and undertake that [name and address of the Bidder] will be provided by us with a revolving line of credit, in case awarded the Contract, for execution of the Works viz. [insert name of the works], for an amount not less than NRs[in figure] (in words) for the sole purpose of the execution of the above Contract. This Revolving Line of Credit will be maintained by us until issuance of "Taking-Over Certificate" by the Procuring Entity.

In witness whereof, authorised representative of the Bank has hereunto signed and sealed this Letter of Commitment.

Signature

Signature

Technical Proposal Format

Personnel

Equipment

Site Organization

Method Statement

Mobilization Schedule

Construction Schedule

Others

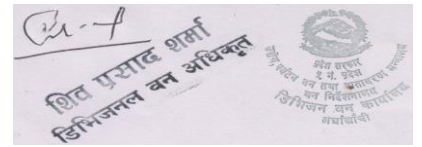

Personnel

Form PER - 1: Proposed Personnel

Bidders should provide the names of suitably qualified personnel to meet the specified requirements for each of the positions listed in Section III (Evaluation and Qualification Criteria). The data on their experience should be supplied using the Form below for each candidate.

No.	Name	Position*	Academic Qualification	Total Work Experience [Years]	Experience in Similar Works [years]
1.					
2.					
3.					
4.					
5.					

* As listed in Section III (Evaluation and Qualification Criteria).

Form PER - 2: Resume of Proposed Personnel

The Bidder shall provide all the information requested below. Fields with asterisk (*) shall be used for evaluation.

Position*		
Personal Information	Name	Date of Birth
	Professional qualifications	
Present employment	Name of employer	
	Address of employer	
	Telephone	Contact (manager/personnel officer)
	Fax	E-mail
	Job title	Years with present employer

Summarize professional experience over the last twenty years in reverse chronological order. Indicate particular technical and managerial experience relevant to the project.

From*	To*	Company, Project, Position and Relevant Technical and Management Experience*

Note:

In case of e-submission the Resume of Proposed Personnel shall be submitted on notification by the Employer as per ITB 27.

Equipment

The Bidder shall provide adequate information to demonstrate clearly that it has the capability to meet the requirements for the key equipment listed in Section III (Evaluation and Qualification Criteria). A separate Form shall be prepared for each item of equipment listed, or for alternative equipment proposed by the Bidder. The Bidder shall provide all the information requested below, to the extent possible. Fields with asterisk (*) shall be used for evaluation.

(i) For the equipment under Bidder's ownership

No.	Equipment Type and Characteristics	Total Nos. of Equipment under Bidder's Ownership	No. of Equipment engaged/proposed for ongoing/committed contracts	Nos. of Equipment proposed for this contract
1.				
2.				
3.				
4.				
5.				

(ii) For the Equipment to be leased/hired

No.	Equipment Type and Characteristics	Total Nos. of Equipment under the ownership of lease/hire provider	No. of Equipment engaged/committed for other works	Nos. of Equipment proposed to be leased/hired for this contract
1.				
2.				
3.				
4.				
5.				

Type of Equipment*		
Equipment Information	Name of manufacturer	Model and power rating
	Capacity*	Year of manufacture
Current Status	Current location	
	Details of current commitments	
Source	Indicate source of the equipment <input type="checkbox"/> Owned <input type="checkbox"/> Rented <input type="checkbox"/> Leased <input type="checkbox"/> Specially manufactured	

The following information shall be provided only for equipment not owned by the Bidder.

Owner	Name of owner	
	Address of owner	
	Telephone	Contact name and title
	Fax	email
Agreements	Details of rental / lease / manufacture agreements specific to the project	

The Bidder shall be solely responsible for the data provided. However, this shall not limit the right of Employer to verify the authenticity of submitted information.

Note:

In case of e-submission the "Agreements" shall be submitted on notification by the Employer as per ITB 27.1

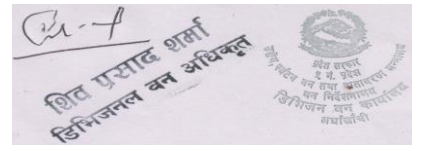

Site Organization

Method Statement

Mobilization Schedule

Construction Schedule

Others

Bidder's Qualification

To establish its qualifications to perform the contract in accordance with Section III (Evaluation and Qualification Criteria) the Bidder shall provide the information requested in the corresponding Information Sheets included hereunder.

Form ELI - 1: Bidder's Information Sheet

Bidder's Information	
Bidder's legal name	
In case of JV, legal name of each partner	
Bidder's country of constitution	
Bidder's year of constitution	
Bidder's legal address in country of constitution	
Bidder's authorized representative (name, address, telephone numbers, fax numbers, e-mail address)	
Attached are copies of the following original documents.	
<ol style="list-style-type: none"> 1. In case of single entity, articles of incorporation or constitution of the legal entity named above, in accordance with ITB 4.1 and 4.2. 2. Authorization to represent the firm or JV named in above, in accordance with ITB 20.2. 3. In case of JV, letter of intent to form JV or JV agreement, in accordance with ITB 4.1. 4. In case of a government-owned entity, any additional documents not covered under 1 above required to comply with ITB 4.5. 	

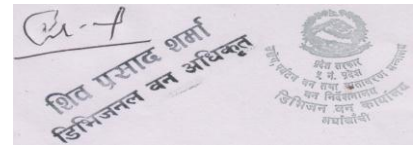

Form ELI - 2: JV Information Sheet

Each member of a JV must fill in this form

JV / Specialist Subcontractor Information	
Bidder's legal name	
JV Partner's or Subcontractor's legal name	
JV Partner's or Subcontractor's country of constitution	
JV Partner's or Subcontractor's year of constitution	
JV Partner's or Subcontractor's legal address in country of constitution	
JV Partner's or Subcontractor's authorized representative information (name, address, telephone numbers, fax numbers, e-mail address)	
Attached are copies of the following original documents.	
<ol style="list-style-type: none">1. articles of incorporation or constitution of the legal entity named above, in accordance with ITB 4.1 and 4.2.2. Authorization to represent the firm named above, in accordance with ITB 20.2.3. In the case of government-owned entity, documents establishing legal and financial autonomy and compliance with commercial law, in accordance with ITB 4.5.	

Dr. A
शिव प्रसाद शर्मा
डिभिजल वन अधिकारी
शिव प्रसाद शर्मा
डिभिजल वन अधिकारी
भारत-की

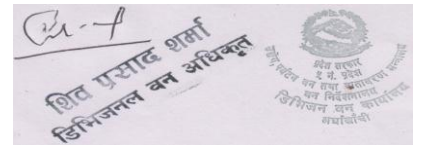

Form LIT - 1: Pending Litigation

Each member of a JV must fill in this form

Pending Litigation			
<input type="checkbox"/> No pending litigation in accordance with Criteria 2.2 of Section III (Evaluation and Qualification Criteria)			
<input type="checkbox"/> Pending litigation in accordance with Criteria 2.2 of Section III (Evaluation and Qualification Criteria)			
Year	Matter in Dispute	Value of Pending Claim in NRS	Value of Pending Claim as a Percentage on Net Worth

Form FIN - 1: Financial Situation

Each Bidder or member of a JV must fill in this form

Financial Data for Previous 3 Years [in NRS]		
Year 1 :	Year 2 :	Year 3 :

Information from Balance Sheet

Total Assets			
Total Liabilities			
Net Worth			
Current Assets			
Current Liabilities			

Information from Income Statement

Total Revenues			
Profit Before Tax			
Profit After Tax			

- Attached are copies of financial statements (balance sheets including all related notes, and income statements) for the last three or above years, as indicated above, complying with the following conditions.
- All such documents reflect the financial situation of the Bidder or partner to a JV, and not sister or parent companies.
- Historic financial statements must be audited by a certified auditor.
- Historic financial statements must be complete, including all notes to the financial statements.
- Historic financial statements must correspond to accounting periods already completed and audited (no statements for partial periods shall be requested or accepted).

Note:

In case of e-submission the attachments should not be uploaded but shall be submitted on notification by the Employer as per ITB 27.1

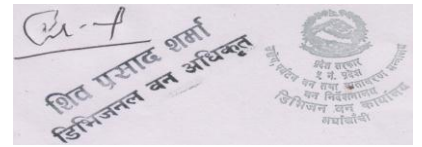

Form FIN - 2: Average Annual Construction Turnover

Each Bidder or member of a JV must fill in this form

The information supplied should be the Annual Turnover of the Bidder or each member of a JV in terms of the amounts billed to clients for each year for work in progress or completed to NRs at the end of the period reported.

Annual Turnover Data for the Last 10 Years (Construction only)	
Year	Amount Currency

- **Average Annual Construction Turnover
(Best three years within the last 10 years)**

--

Form FIN - 3: Financial Resources

Specify proposed sources of financing, such as liquid assets, unencumbered real assets, lines of credit, and other financial means, net of current commitments, available to meet the total construction cash flow demands of the subject contract or contracts as indicated in Section III (Evaluation and Qualification Criteria).

Financial Resources		
No.	Source of financing	Amount (in NRS)
1		
2		
3		

Note : The letter from the Bank must be Unconditional in the format and stated details/terms and conditions as per the Bid Forms "Letter of Commitment for Bank's Undertaking for Line of Credit"

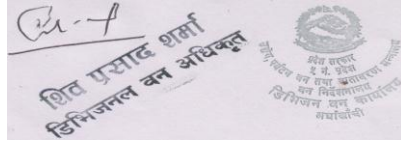

Form EXP - 1: General Construction Experience

Each Bidder or member of a JV must fill in this form.

General Construction Experience				
Starting Month Year	Ending Month Year	Year	Contract Identification and Name and Address of Employer Brief Description of the Works Executed by the Bidder	Role of Bidder

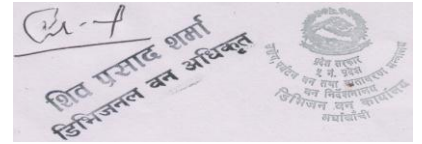

Form EXP - 2(a): Specific Construction Experience

Fill up one (1) form per contract.

Contract of Similar Size and Nature			
Contract No..... of.....	Contract Identification		
Award Date		Completion Date	
Role in Contract	<input type="checkbox"/> Contractor	<input type="checkbox"/> Management Contractor	<input type="checkbox"/> Subcontractor
Total Contract Amount	<input type="checkbox"/> NRS		
If Partner in a JV or subcontractor, specify participation of total contract amount	Percent of Total	Amount	
Employer's Name Address Telephone/Fax Number E-mail			
Description of the similarity in accordance with Criteria 2.4.2 (a) of Section III			
<p>Note :</p> <p><i>The Employer should insert here contract size, complexity, methods, technology, or other characteristics as described in Section VI (Work Requirements) against which the bidder demonstrates similarity in the box on the right-hand-side.</i></p>			

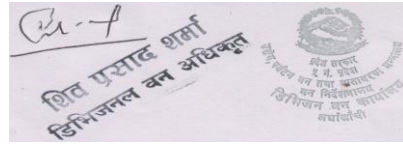

Form EXP - 2(b): Specific Construction Experience in Key Activities

Fill up one (1) form per contract.

Contract of Similar Size and Nature			
Contract No..... of.....		Contract Identification	
Award Date		Completion Date	
Role in Contract	<input type="checkbox"/> Contractor	<input type="checkbox"/> Management Contractor	<input type="checkbox"/> Subcontractor
Total Contract Amount	<input type="checkbox"/> NRS		
If Partner in a JV or subcontractor, specify participation of total contract amount	Percent of Total	Amount	
Employer's Name Address Telephone/Fax Number E-mail			
Description of the similarity in accordance with Criteria 2.4.2 (a) of Section III			
<p>Note :</p> <p><i>The Employer should insert here production rate(s) for the key activity (activities) subject contract against which the bidder demonstrates in the box on the right-hand-side production rates achieved by him on previous contracts.</i></p>			

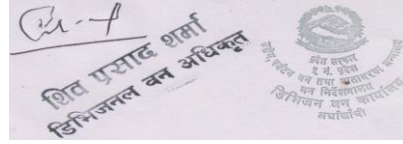
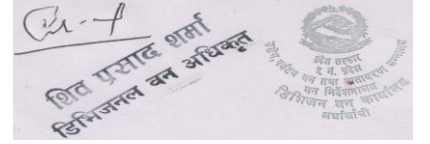

Table of Clauses

Scope of Work	77
Specifications	78
Notes on the Specifications	78
Sample Clause: Equivalency of Standards and Codes	79
Drawings	81
Supplementary Information	82
Section VI: Bill of Quantities	83
Notes for Unit Rate Contracts:	83
Preamble of Bill of Quantities	85
A. General	85
B. Day work Schedule	86
Provisional Sums	87
Bill of Quantities	88



Section VI: Works Requirements

This Section contains the Specification, the Drawings, and supplementary information that describe the Works to be procured.

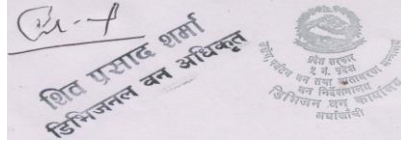

Scope of Work

[Insert brief scope of works.]

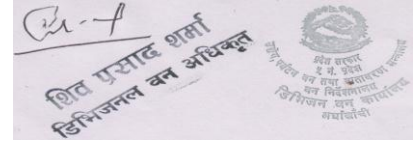

Specifications

Notes on the Specifications

A set of precise and clear specifications is a prerequisite for Bidders to respond realistically and competitively to the requirements of the Employer without qualifying or conditioning their Bids. The specifications must be drafted to permit the widest possible competition and, at the same time, present a clear statement of the required standards of workmanship, materials, and performance of the goods and services to be procured. Only if this is done will the objectives of economy, efficiency and fairness in procurement be realized, responsiveness of Bids be ensured, and the subsequent task of bid evaluation facilitated. The specifications should require that all goods and materials to be incorporated in the Works be new, unused, of the most recent or current models, and incorporate all recent improvements in design and materials unless provided otherwise in the Contract.

Samples of specifications from previous similar projects are useful in this respect. The use of metric units is encouraged by the Funding Agency in case of funding assisted projects. Most specifications are normally written specially by the Employer or Project Manager to suit the Contract Works in hand. The available standard specification of works of Ministry of Physical Infrastructure and Transport, DoLIDAR and Other line Ministries can be adopted for respective civil construction works.

There are considerable advantages in standardizing General Specifications for repetitive Works in recognized public sectors, such as highways, urban housing, irrigation, and water supply, in the same country or region where similar conditions prevail. The General Specifications should cover all classes of workmanship, materials, and equipment commonly involved in construction, however it may not necessarily be adequate to be used in a particular Works Contract and may necessitate preparation of Particular (Special) Specifications to amend and or supplement the provision of the General Specifications to meet the requirement of the particular Works.

Care must be taken in drafting specifications to ensure that they are not restrictive. In the specification of standards for goods, materials, and workmanship, recognized international standards should be used as much as possible. Where other particular standards are used, whether national standards of Nepal or other standards, the specifications should state that goods, materials, and workmanship that meet other authoritative standards, and which ensure substantially equal or higher quality than the standards mentioned, will also be acceptable.

Employers should decide whether technical solutions to specified parts of the Works are to be permitted. Alternatives are appropriate in cases where obvious (and potentially less costly) alternatives are possible to the technical solutions indicated in the Procurement Documents for certain elements of the Works, taking into consideration the comparative specialized advantage of potential bidders. For example:

The Employer should provide a description of the selected parts of the Works with appropriate references to Drawings, Specifications, Bill of Quantities, and Design or Performance criteria, stating that the alternative solutions if applicable shall be at least structurally and

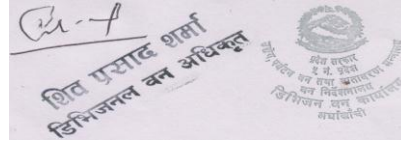

functionally equivalent to the basic design parameters and specifications.

Such alternative solutions shall be accompanied by all information necessary for a complete evaluation by the Employer, including drawings, design calculations, technical specifications, breakdown of prices, proposed construction methodology, and other relevant details.

Sample Clause: Equivalency of Standards and Codes

Wherever reference is made in the Contract to specific standards and codes to be met by the goods and materials to be furnished, and work performed or tested, the provisions of the latest current edition or revision of the relevant standards and codes in effect shall apply, unless otherwise expressly stated in the Contract. Where such standards and codes are national, or relate to a particular country or region, other authoritative standards that ensure a substantially equal or higher quality than the standards and codes specified will be accepted subject to the Project Manager's prior review and written consent. Differences between the standards specified and the proposed alternative standards shall be fully described in writing by the Contractor and submitted to the Project Manager at least 30 days prior to the date when the Contractor desires the Project Manager's consent. In the event the Project Manager determines that such proposed deviations do not ensure substantially equal or higher quality, the Contractor shall comply with the standards specified in the documents.

These Notes for Preparing Specifications are intended only as information for the Employer or the person drafting the Procurement Documents. They should not be included in the final documents.

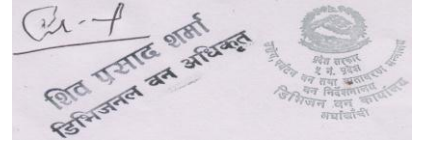

[Insert Specifications]

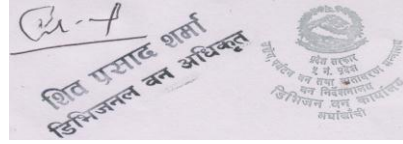

Drawings

Note:

1. It is customary to bind the drawings in a separate volume, which is often larger than other volumes of the contract documents. The size will be dictated by the scale of the drawings, which must not be reduced to the extent that details are reduced illegible.
2. A simplified map showing the location of the Site in relation to the local geography, indicating major roads, posts, airports, and railroads, is helpful.
3. The construction drawings, even if not fully developed, must show sufficient details to enable bidders to understand the type and complexity of the work involved and the price the Bill of Quantities.

Drawings Will Be Available In Separate Volume

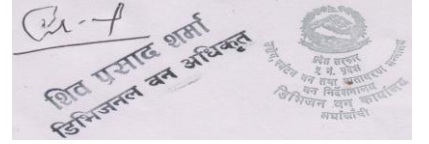

Supplementary Information

[insert supplementary information if any]

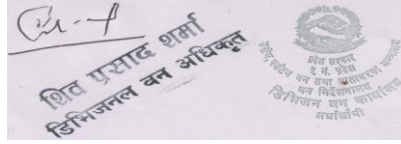

Section VI: Bill of Quantities²

Notes for Unit Rate Contracts:

Objectives

The objectives of the Bill of Quantities are

- (a) to provide sufficient information on the quantities of Works to be performed to enable Bids to be prepared efficiently and accurately; and
- (b) when a Contract has been entered into, to provide a priced Bill of Quantities for use in the periodic valuation of Works executed.

In order to attain these objectives, Works should be itemized in the Bill of Quantities in sufficient detail to distinguish between the different classes of Works, or between Works of the same nature carried out in different locations or in other circumstances which may give rise to different considerations of cost. Consistent with these requirements, the layout and content of the Bill of Quantities should be as simple and brief as possible.

Content

The Bill of Quantities should be divided generally into the following sections:

- (a) Preamble;
- (b) Work Items (grouped into parts);
- (c) Day works Schedule;
- (d) Provisional Sums; and
- (d) Summary.

Preamble

The Preamble should indicate the inclusiveness of the unit prices, and should state the methods of measurement which have been adopted in the preparation of the Bill of Quantities and which are to be used for the measurement of any part of the works.

Work Items

The items in the Bill of Quantities should be grouped into sections to distinguish between those parts of the Works which by nature, location, access, timing, or any other special characteristics may give rise to different methods of construction, or phasing of the Works, or considerations of cost. General items common to all parts of the works may be grouped as a separate section in the Bill of Quantities.

Day work Schedule

A Day work Schedule should be included only if the probability of unforeseen work, outside the items included in the Bill of Quantities, is high. To facilitate checking by the Employer of the realism of rates quoted by the Bidders, the Day work Schedule should normally comprise the following:

²In lump sum contracts, delete “Bill of Quantities” and replace with “Schedule of Activities” throughout this section.

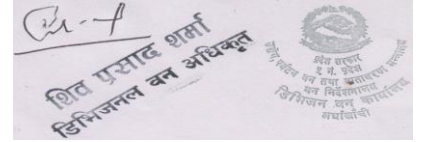

- (a) A list of the various classes of labor, materials, and Constructional Plant for which basic day work rates or prices are to be inserted by the Bidder, together with a statement of the conditions under which the Contractor will be paid for work executed on a day work basis.
- (b) Nominal quantities for each item of Day work, to be priced by each Bidder at Day work rates as bid. The rate to be entered by the Bidder against each basic Day work item should include the Contractor's profit, overheads, supervision, and other charges.

Provisional Sums

Provisional Sums included and so designated in the Bill of Quantities shall be expended in whole or in part at the direction and discretion of the Project Manager in accordance with the Conditions of Contract.

Summary

The Summary should contain a tabulation of the separate parts of the Bill of Quantities carried forward, with provisional sums for Day work, for physical (quantity) contingencies, and for price contingencies (upward price adjustment) where applicable.

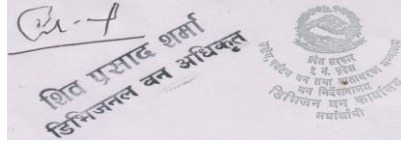

Preamble of Bill of Quantities

A. General

1. The Bill of Quantities shall be read in conjunction with the Instructions to Bidders, General and Special Conditions of Contract, Technical Specifications, and Drawings.
2. The quantities given in the Bill of Quantities are estimated and provisional, and are given to provide a common basis for bidding. The basis of payment will be the actual quantities of work ordered and carried out, as measured by the Contractor and verified by the Project Manager and valued at the rates and prices bid in the priced Bill of Quantities, where applicable, and otherwise at such rates and prices as the Project Manager may fix within the terms of the Contract.
3. For any item for which measurement is based on records made before or during construction the records shall be prepared and agreed between the Engineer and the Contractor. Should the Contractor carry out such work without the prior agreement of the Engineer, the Engineer may request the Contractor to carry out investigations to confirm the extent of the work and the quantity of work certified for payment shall be solely at the Engineer's discretion. The cost of any such investigation shall be borne by the Contractor.
4. The rates and prices bid in the priced Bill of Quantities shall, except as otherwise provided under the Contract, include all construction equipment, labor, supervision, materials, erection, maintenance, insurance, profit, taxes, and duties, together with all general risks, liabilities, and obligations set out or implied in the Contract.
5. A rate or price shall be entered against each item in the priced Bill of Quantities, whether quantities are stated or not. The cost of items against which the Contractor has failed to enter a rate or price shall be deemed to be covered by other rates and prices entered in the Bill of Quantities.
6. The whole cost of complying with the provisions of the Contract shall be included in the Items provided in the priced Bill of Quantities, and where no Items are provided, the cost shall be deemed to be distributed among the rates and prices entered for the related Items of Work.
7. General directions and descriptions of work and materials are not necessarily repeated nor summarized in the Bill of Quantities. References to the relevant sections of the Contract documentation shall be made before entering prices against each item in the priced Bill of Quantities. The Specification Clause references where given in the item description of the Bills of Quantities are for the convenience of bidders and generally refer to the principal relevant-specification clause but do not necessarily represent the whole of the specification requirements for the work required within the item. The presence of a Specification clause reference shall not in any way reduce the Bidders obligation to complete work in accordance with all the requirements of the Specification.
8. Provisional Sums included and so designated in the Bill of Quantities shall be expended in whole or in part at the direction and discretion of the Project Manager in accordance with the Conditions of Contract.
9. The method of measurement of completed work for payment shall be in accordance with the Specifications.
10. The abbreviations and symbols used in this Bill of Quantities are: **[Insert as applicable]**

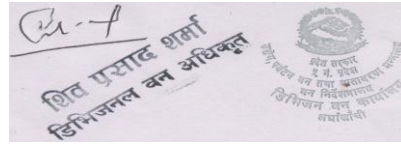

Provisional Sums

A general provision for physical contingencies (quantity overruns) may be made by including a provisional sum in the Summary Bill of Quantities. Similarly, a contingency allowance for possible price increases should be provided as a provisional sum in the Summary Bill of Quantities. The inclusion of such provisional sums often facilitates budgetary approval by avoiding the need to request periodic supplementary approvals as the future need arises. Where such provisional sums or contingency allowances are used, the SCC should state the manner in which they will be used, and under whose authority (usually the Project Manager's).

The estimated cost of specialized work to be carried out, or of special goods to be supplied, by other contractors should be indicated in the relevant part of the Bill of Quantities as a particular provisional sum with an appropriate brief description. A separate procurement procedure is normally carried out by the Employer to select such specialized contractors. To provide an element of competition among the Bidders in respect of any facilities, amenities, attendance, etc., to be provided by the successful Bidder as prime Contractor for the use and convenience of the specialist contractors, each related provisional sum should be followed by an item in the Bill of Quantities inviting the Bidder to quote a sum for such amenities, facilities, attendance, etc.

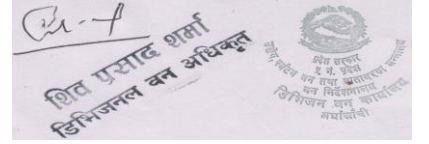

Bill of Quantities

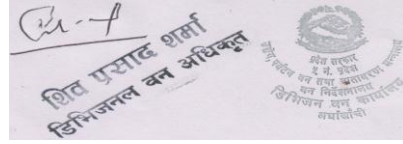

Part III: CONDITIONS OF CONTRACT AND CONTRACT FORMS

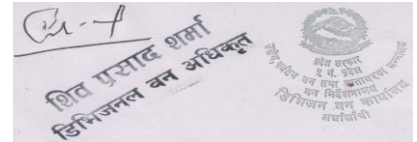
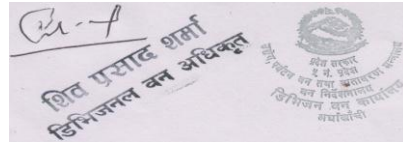
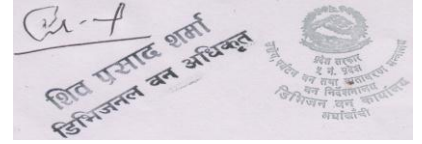

Table of Clauses

A.	General	92
	1. Definitions.....	92
	2. Interpretation	94
	3. Language and Law	95
	4. Contract Agreement.....	95
	5. Assignment.....	95
	6. Care and Supply of Documents	95
	7. Confidential Details.....	96
	8. Compliance with Laws	96
	9. Joint and Several Liability	96
	10. Project Manager's Decisions.....	96
	11. Delegation	96
	12. Communications.....	97
	13. Subcontracting.....	97
	14. Other Contractors	97
	15 Personnel and Equipment.....	97
	16. Employer's and Contractor's Risk	97
	17. Employer's Risks	97
	18. Contractor's Risks.....	98
	19. Insurance	98
	20. Site Investigation Reports	99
	21. Contractor to Construct the Works	99
	22. The Works to Be Completed within intended Completion Date	99
	23. Design by contractor and Approval by the Project Manager	99
	24. Safety, Security and Protection of the Environment	99
	25. Discoveries.....	100
	26. Possession of the Site	100
	27. Access to the Site	100
	28. Instructions, Inspections and Audits.....	100
	29. Dispute Settlement	100
	30. Procedures for Disputes	101
B.	Staff and Labor	101
	31. Forced Labor	101
	32. Child Labor	101
	33. Nondiscrimination and Equal Opportunity	101
B.	Time Control.....	101
	34. Program	101
	35. Extension of the IntendedCompletion Date.....	102
	36. Acceleration.....	102
	37. Delays Ordered by the Project Manager	102
	38. Management Meetings	102
	39. Early Warning	103
C.	Quality Control.....	103
	40. Identifying Defects	103
	41. Tests.....	103
	42. Correction of Defects	103
	43. Uncorrected Defects	103
D.	Cost Control	103
	44. Contract Price	103



45. Changes in the Contract Price.....	104
46. Variations	104
47. Cash Flow Forecasts	105
48. Payment Certificates.....	105
49. Payments.....	105
50. Compensation Events.....	105
51. Tax	107
52. Currency.....	107
53. Price Adjustment.....	107
54. Retention	109
55. Liquidated Damages.....	109
56. Bonus	109
57. Advance Payment.....	109
58. Securities	110
59. Dayworks.....	110
60. Cost of Repairs.....	110
F. Force Majeure.....	110
61. Definition of Force Majeure.....	111
62. Notice of Force Majeure.....	111
63. Duty to Minimize Delay	111
64. Consequences of Force Majeure	112
65. Force Majeure Affecting Subcontractor.....	112
66. Optional Termination, Payment and Release.....	112
67. Release from Performance	113
G. Finishing the Contract.....	113
68. Completion	113
69. Taking Over	113
70. Final Account.....	113
71. Operating and Maintenance Manuals	114
72. Termination.....	114
73. Fraud and Corruption.....	115
74. Black Listing	116
75. Payment upon Termination.....	116
76. Property.....	116
77. Release from Performance	116
78. Suspension of DP Loan/Credit/Grant.....	117
79. Eligibility	117
80. Project Manager's Duties and Authorities	117
81. Quarries and Spoil Dumps.....	117
82. Local Taxation	117
83. Value Added Tax.....	118
84. Income Taxes on Staff.....	118
85. Duties, Taxes and Royalties	118
86. Member of Government, etc, not Personally Liable.....	118
87. Approval of Use of Explosives	118
89. Permission for Blasting	119
90. Records of Explosives	119
91. Traffic Diversion.....	119



Section VIII: General Conditions of Contract

Division Forest Office

Tourism Infrastructure Construction At Panini Tapobhumi

General Conditions of Contract

A. General	
1. Definitions	<p>1.1 Boldface type is used to identify defined terms.</p> <p>(a) The Accepted Contract Amount means the amount accepted in the Letter of Acceptance for the execution and completion of the Works and the remedying of any defects.</p> <p>(b) The Activity Schedule is a schedule of the activities comprising the construction, installation, testing, and commissioning of the Works in a lump sum contract. It includes a lump sum price for each activity, which is used for valuations and for assessing the effects of Variations and Compensation Events.</p> <p>(c) The Adjudicator is the person appointed jointly by the Employer and the Contractor to resolve disputes in the first instance, as provided for in GCC 23.2 hereunder.</p> <p>(d) Bill of Quantities means the priced and completed Bill of Quantities forming part of the Bid.</p> <p>(e) Compensation Events are those defined in GCC 50 hereunder.</p> <p>(f) The Completion Date is the date of completion of the Works as certified by the Project Manager, in accordance with GCC 68.1.</p> <p>(g) The Contract is the Contract between the Employer and the Contractor</p>

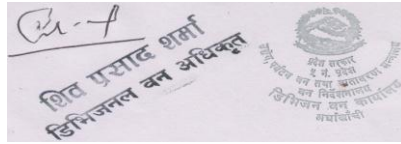

to execute, complete, and maintain the Works. It consists of the documents listed in GCC 2.3 below.

(h) The **Contractor** is the party whose Bid to carry out the Works has been accepted by the Employer.

(i) The **Contractor's Bid** is the completed bidding document submitted by the Contractor to the Employer.

(j) The **Contract Price** is the Accepted Contract Amount stated in the Letter of Acceptance and thereafter as adjusted in accordance with the Contract.

(k) **Days** are calendar days; months are calendar-months.

(l) **Dayworks** are varied work inputs subject to payment on a time basis for the Contractor's employees and Equipment, in addition to payments for associated Materials and Plant.

(m) A **Defect** is any part of the Works not completed in accordance with the Contract.

(n) The **Defects Liability Certificate** is the certificate issued by Project Manager upon correction of defects by the Contractor.

(o) The **Defects Liability Period** is the period calculated from the Completion Date where the Contractor remains responsible for remedying defects.

(p) **Drawings** include calculations and other information provided or approved by the Project Manager for the execution of the Contract.

(q) The **Employer** is the party who employs the Contractor to carry out the Works, as **specified in the SCC**.

(r) **Equipment** is the Contractor's machinery and vehicles brought temporarily to the Site to construct the Works.

(s) **Force Majeure** means an exceptional event or circumstance: which is beyond a Party's control; which such Party could not reasonably have provided against before entering into the Contract; which, having arisen, such Party could not reasonably have avoided or overcome; and, which is not substantially attributable to the other Party.

(t) The **Initial Contract Price** is the Contract Price listed in the Employer's Letter of Acceptance.

(u) **In writing** or **written** means hand written, type written, printed or electronically made, and resulting in permanent record.

(v) The **Intended Completion Date** is the date on which it is intended that the Contractor shall complete the Works. The Intended Completion Date is **specified in the SCC**. The Intended Completion Date may be revised only by the Project Manager by issuing an extension of time or an acceleration order.

(w) **Letter of Acceptance** means the formal acceptance by the Employer of the Bid and denotes the formation of the contract at the date of acceptance.

(x) **Materials** are all supplies, including consumables, used by the Contractor for incorporation in the Works.

(y) **Party** means the Employer or the Contractor, as the context requires.

(z) **SCC** means Special Conditions of Contract

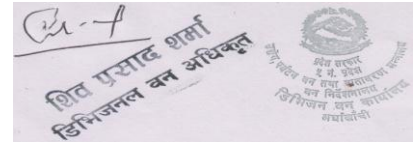

	<p>(aa) Plant is any integral part of the Works that shall have a mechanical, electrical, chemical, or biological function.</p> <p>(bb) The Project Manager is the person named in the SCC (or any other competent person appointed by the Employer and notified to the Contractor, to act in replacement of the Project Manager) who is responsible for supervising the execution of the Works and administering the Contract.</p> <p>(cc) Retention Money means the aggregate of all monies retained by the Employer pursuant to GCC 54.1.</p> <p>(dd) Schedules means the document(s) entitled schedules, completed by the Contractor and submitted with the Letter of Bids, as included in the Contract. Such document may include the Bill of Quantities, data, lists, and schedules of rates and/or prices.</p> <p>(ee) The Site is the area defined as such in the SCC</p> <p>(ff) Site Investigation Reports are those that were included in the bidding documents and are factual and interpretative reports about the surface and subsurface conditions at the Site.</p> <p>(gg) Specification means the Specification of the Works included in the Contract and any modification or addition made or approved by the Project Manager.</p> <p>(hh) The Start Date is given in the SCC. It is the latest date when the Contractor shall commence execution of the Works. It does not necessarily coincide with any of the Site Possession Dates.</p> <p>(ii) A Subcontractor is a person or corporate body who has a Contract with the Contractor to carry out a part of the work in the Contract, which includes work on the Site.</p> <p>(jj) Temporary Works are works designed, constructed, installed, and removed by the Contractor that are needed for construction or installation of the Works.</p> <p>(kk) A Variation is an instruction given by the Project Manager which varies the Works</p> <p>(ll) The Works are what the Contract requires the Contractor to construct, install, and turn over to the Employer, as defined in the SCC.</p>
<p>2. Interpretation</p>	<p>2.1 In interpreting these GCC, singular also means plural, male also means female or neuter, and the other way around. Headings have no significance. Words have their normal meaning under the language of the Contract unless specifically defined. The Project Manager shall provide instructions clarifying queries about these GCC.</p> <p>2.2 If sectional completion is specified in the SCC, references in the GCC to the Works, the Completion Date, and the Intended Completion Date apply to any Section of the Works (other than references to the Completion Date and Intended Completion Date for the whole of the Works).</p> <p>2.3 The documents forming the Contract shall be interpreted in the following order of priority:</p> <p>(a) Contract Agreement,</p>

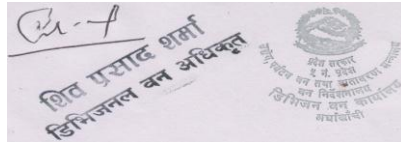

	<p>(b) Letter of Acceptance,</p> <p>(c) Letters of Technical Bid and Price Bid,</p> <p>(d) Special Conditions of Contract,</p> <p>(e) General Conditions of Contract,</p> <p>(f) Specifications,</p> <p>(g) Drawings,</p> <p>(h) Bill of Quantities (or Schedules of Prices for lump sum contracts), and</p> <p>(i) Any other document listed in the SCC as forming part of the Contract.</p>
<p>3. Language and Law</p>	<p>3.1 The language of the Contract and the law governing the Contract are stated in the SCC.</p> <p>3.2. Throughout the execution of the Contract, the Contractor shall comply with the import of goods and services prohibitions in the Employer's country when</p> <p>(a) by an act of compliance with a decision of the United Nations Security Council taken under Chapter VII of the Charter of the United Nations, the Borrower's Country prohibits any import of goods from, or any payments to, a particular country, person, or entity. Where the borrower's country prohibits payments to a particular firm or for particular goods by such an act of compliance, that firm may be excluded.</p>
<p>4. Contract Agreement</p>	<p>4.1 The Parties shall enter into a Contract Agreement within 15 days after the Contractor receives the Letter of Acceptance, unless the Special Conditions establish otherwise. The Contract Agreement shall be based upon the attached Contract forms in Section X.</p>
<p>5. Assignment</p>	<p>5.1 Neither Party shall assign the whole or any part of the Contract or any benefit or interest in or under the Contract. However, either Party</p> <p>(a) may assign the whole or any part with the prior agreement of the other Party, at the sole discretion of such other Party; and</p> <p>(b) may, as security in favor of a bank or financial institution, assign its right to any moneys due, or to become due, under the Contract.</p>
<p>6. Care and Supply of Documents</p>	<p>6.1 The Specification and Drawings shall be in the custody and care of the Employer. Unless otherwise stated in the Contract, one copy of the Contract and of each subsequent Drawing shall be supplied to the Contractor, who may make or request further copies at the cost of the Contractor.</p> <p>6.2 Each of the Contractor's Documents shall be in the custody and care of the Contractor, unless and until taken over by the Employer. Unless otherwise stated in the Contract, the Contractor shall supply to the Engineer six copies of each of the Contractor's Documents.</p>

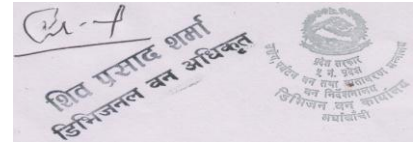

	<p>6.3 The Contractor shall keep, on the Site, a copy of the Contract, publications named in the Specification, the Contractor's Documents (if any), the Drawings and Variations and other communications given under the Contract. The Employer's Personnel shall have the right of access to all these documents at all reasonable times.</p> <p>6.4 If a Party becomes aware of an error or defect in a document which was prepared for use in executing the Works, the Party shall promptly give notice to the other Party of such error or defect.</p>
<p>7. Confidential Details</p>	<p>7.1 The Contractor's and the Employer's Personnel shall disclose all such confidential and other information as may be reasonably required in order to verify the Contractor's compliance with the Contract and allow its proper implementation.</p> <p>7.2 Each of them shall treat the details of the Contract as private and confidential, except to the extent necessary to carry out their respective obligations under the Contract or to comply with applicable Laws. Each of them shall not publish or disclose any particulars of the Works prepared by the other Party without the previous agreement of the other Party. However, the Contractor shall be permitted to disclose any publicly available information, or information otherwise required to establish his qualifications to compete for other projects.</p> <p>7.3 Notwithstanding the above, the Contractor may furnish to its Subcontractor(s) such documents, data and other information it receives from the Employer to the extent required for the Subcontractor(s) to perform its work under the Contract, in which event the Contractor shall obtain from such Subcontractor(s) an undertaking of confidentiality similar to that imposed on the Contractor under this Clause.</p>
<p>8. Compliance with Laws</p>	<p>8.1 The Contractor shall, in performing the Contract, comply with applicable Laws.</p>
<p>9. Joint and Several Liability</p>	<p>9.1 If the Contractor is a joint venture of two or more entities , all such entities shall be jointly and severally liable to the Employer for the fulfillment of the provisions of the Contract, and shall designate one of such persons to act as a leader with authority to bind the joint venture. The contractor shall not handover the responsibility of the contract to any one member or some members of Joint Venture or any other parties, not involved in the contract. The composition or the constitution of the joint venture shall not be altered without the prior consent of the Employer.</p>
<p>10. Project Manager's Decisions</p>	<p>10.1 Except where otherwise specifically stated, the Project Manager shall decide contractual matters between the Employer and the Contractor in the role representing the Employer.</p>
<p>11. Delegation</p>	<p>11.1 The Project Manager may delegate any of his duties and responsibilities to other people after notifying the Contractor, and may cancel any</p>

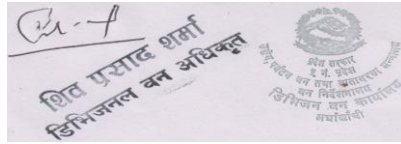

	delegation after notifying the Contractor.
12. Communications	12.1 Communications between parties that are referred to in the Conditions shall be effective only when in writing. A notice shall be effective only when it is delivered.
13. Subcontracting	<p>13.1 For GoN Funded:</p> <p>A list of approved Subcontractors including its value/works is included as Article 2 (k) of contract Agreement. Approval by the Employer for any of the Subcontractors shall not relieve the Contractor from any of its obligations, duties, or responsibilities under the contract.</p> <p>For DP Funded :</p> <p>The Contractor may subcontract with the approval of the Project Manager, but may not assign the Contract without the approval of the Employer in writing. Subcontracting shall not alter the Contractor's obligations. Bidders may propose subcontracting up to the percentage of total value of contracts as specified in the SCC. The Sub contractor shall meet the qualification requirement as specified in SCC.</p>
14. Other Contractors	14.1 The Contractor shall cooperate and share the Site with other contractors, public authorities, utilities, and the Employer between the dates given in the Schedule of Other Contractors, as referred to in the SCC . The Contractor shall also provide facilities and services for them as described in the Schedule. The Employer may modify the Schedule of Other Contractors, and shall notify the Contractor of any such modification
15 Personnel and Equipment	<p>15.1 The Contractor shall employ the key personnel and use the equipment identified in its Bid to carry out the Works, or other personnel and equipment approved by the Project Manager. The Project Manager shall approve any proposed replacement of key personnel and equipment only if their relevant qualifications or characteristics are substantially equal to or better than those proposed in the Bid.</p> <p>15.2 If the Project Manager asks the Contractor to remove a person who is a member of the Contractor's staff or work force, stating the reasons, the Contractor shall ensure that the person leaves the Site within seven days and has no further connection with the work in the Contract.</p> <p>15.3 If the Employer, Project Manager, or Contractor determines, that any employee of the Contractor be determined to have engaged in corrupt, fraudulent, collusive, coercive, or other prohibited practices during the execution of the Works, then that employee shall be removed in accordance with Clause 15.2 above.</p>
16. Employer's and Contractor's Risk	16.1 The Employer carries the risks which this Contract states are Employer's risks, and the Contractor carries the risks which this Contract states are Contractor's risks.
17. Employer's Risks	17.1 From the Start Date until the Defects Liability Certificate has been issued, the following are Employer's risks:

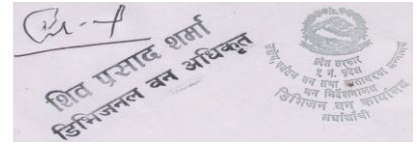

	<p>(a) The risk of personal injury, death, or loss of or damage to property (excluding the Works, Plant, Materials, and Equipment), which are due to</p> <ul style="list-style-type: none"> (i) use or occupation of the Site by the Works or for the purpose of the Works, which is the unavoidable result of the Works or (ii) negligence, breach of statutory duty, or interference with any legal right by the Employer or by any person employed by or contracted to him except the Contractor. <p>(b) The risk of damage to the Works, Plant, Materials, and Equipment to the extent that it is due to a fault of the Employer or in the Employer's design, or due to war or radioactive contamination directly affecting the country where the Works are to be executed.</p> <p>17.2 From the Completion Date until the Defects Liability Certificate has been issued, the risk of loss of or damage to the Works, Plant, and Materials is an Employer's risk except loss or damage due to</p> <ul style="list-style-type: none"> (a) a Defect which existed on the Completion Date, (b) an event occurring before the Completion Date, which was not itself an Employer's risk, or (c) the activities of the Contractor on the Site after the Completion Date.
<p>18. Contractor's Risks</p>	<p>18.1 From the Starting Date until the Defects Liability Certificate has been issued, the risks of personal injury, death, and loss of or damage to property (including, without limitation, the Works, Plant, Materials, and Equipment) which are not Employer's risks are Contractor's risks.</p>
<p>19. Insurance</p>	<p>19.1 The Contractor shall provide insurance in the joint names of the Employer and the Contractor from the Start Date to the end of the Defects Liability Period, in the amounts and deductibles stated in the SCC for the following events which are due to the Contractor's risks:</p> <ul style="list-style-type: none"> (a) loss of or damage to the Works, Plant, and Materials; (b) loss of or damage to Equipment; (c) loss of or damage to property (except the Works, Plant, Materials, and Equipment) in connection with the Contract; and (d) Personal injury or death. <p>19.2 Policies and certificates for insurance shall be delivered by the Contractor to the Project Manager for the Project Manager's approval before the Start Date. All such insurance shall provide for compensation to be payable in the proportions of Nepalese Rupees required to rectify the loss or damage incurred.</p> <p>19.3 If the Contractor does not provide any of the policies and certificates required, the Employer may affect the insurance which the Contractor should have provided and recover the premiums the Employer has paid from payments otherwise due to the Contractor or, if</p>

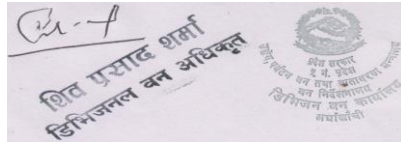

	<p>no payment is due, the payment of the premiums shall be a debt due.</p> <p>19.4 Alterations to the terms of insurance shall not be made without the approval of the Project Manager.</p> <p>19.5 Both parties shall comply with any conditions of the insurance policies.</p>
20. Site Investigation Reports	20.1 The Contractor, in preparing the Bid, shall rely on any Site Investigation Reports referred to in the SCC , supplemented by any information available to the Contractor.
21. Contractor to Construct the Works	21.1 The Contractor shall construct and install the Works in accordance with the Specifications and Drawings.
22. The Works to Be Completed within intended Completion Date	22.1 The Contractor may commence execution of the Works on the Start Date and shall carry out the Works in accordance with the Program submitted by the Contractor, as updated with the approval of the Project Manager, and complete them within the intended Completion Date.
23. Design by contractor and Approval by the Project Manager	<p>23.1 The contractor shall be responsible for the design of permanent works as specified in SCC.</p> <p>23.2 Contractor shall be responsible for design of the Temporary Works. The Contractor shall submit Specifications and Drawings showing the proposed Temporary Works to the Project Manager, for his approval.</p> <p>23.3 All Drawings prepared by the Contractor for the execution of the temporary or permanent Works, shall be subject to prior approval by the Project Manager before their use.</p> <p>23.4 The Project Manager's approval shall not alter the Contractor's responsibility for design of temporary works.</p>
24. Safety, Security and Protection of the Environment	<p>24.1 The Contractor shall, throughout the execution, and completion of the works and remedying of any defects therein:</p> <ol style="list-style-type: none"> a. Have full regard for the safety of all persons entitled to be upon the site and keep the site (so as the same is under his control) and the works (so far as the same are not completed or occupied by the Employer) in an orderly state appropriate to the avoidance of danger to such persons. b. Provide and maintain at his own cost all lights, guards, fencing, warning signs and watching, when necessary or required by the Project Manager or by any duly constituted authority, for the protection of the Works of for the safety and convenience of the public or others. c. Take all reasonable steps to protect the environment on and off the site and to avoid damage or nuisance to persons or to property of the public or others resulting from pollution, noise or other causes arising as a consequence of his methods of operation. d. Ensure that any cut or fill slopes are planted in grass or other plant

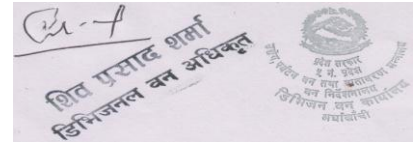

	<p>cover as soon as possible to protect them from erosion.</p> <p>e. Any spoil or material removed from drains shall be disposed of to designated stable tipping areas as directed by the Project Manager.</p> <p>f. Shall not use fuel wood as a means of heating during the processing or preparation of any materials forming part of the works.</p> <p>g. The Project Manager shall have the power to disallow any working practice or activity of the Contractor or direct that such practices or activities be modified should the Project Manager consider, on the advice of the relevant Government Departments, that the practices or activities will be harmful to wildlife.</p> <p>h. Provide on the Site such lifesaving apparatus as may be appropriate and an adequate and easily accessible first aid outfit or such outfits as may be required by any government ordinance, factory act, etc., subsequently published and amended from time to time.</p>
25. Discoveries	25.1 Anything of historical or other interest or of significant value unexpectedly discovered on the Site shall be the property of the employer. The Contractor shall notify the Project Manager of such discoveries and carry out the Project Manager's instructions for dealing with them.
26. Possession of the Site	26.1 The Employer shall give possession of all parts of the Site to the Contractor. If possession of a part is not given by the date stated in the SCC , the Employer shall be deemed to have delayed the start of the relevant activities, and this shall be a Compensation Event.
27. Access to the Site	27.1 The Contractor shall allow the Project Manager and any person authorized by the Project Manager access to the Site and to any place where work in connection with the Contract is being carried out or is intended to be carried out.
28. Instructions, Inspections and Audits	<p>28.1 The Contractor shall carry out all instructions of the Project Manager which comply with the applicable laws where the Site is located.</p> <p>28.2 The Contractor shall keep, and shall make all reasonable efforts to cause its Subcontractors and sub consultants to keep accurate and systematic accounts and records in respect of the Works in such form and details as will clearly identify relevant time changes and costs.</p> <p>28.3 The Contractor shall permit the GoN/DP and/or persons appointed by the GoN/DP to inspect the Site and/or the accounts and records of the Contractor and its sub-contractors relating to the performance of the Contract, and to have such accounts and records audited by auditors appointed by the GoN/DP if required by the GoN/DP. The Contractor's attention is drawn to Sub-Clause 73.2 which provides, inter alia, that acts intended to materially impede the exercise of the GoN's/DP's inspection and audit rights provided for under this Sub-Clause constitute a obstructive practice subject to contract termination.</p>
29. Dispute	29.1 The Employer and the Contractor shall attempt to settle amicably by

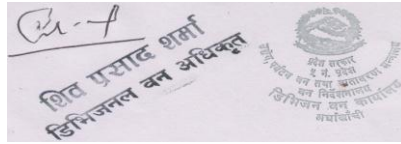

Settlement	<p>direct negotiation any disagreement or dispute arising between them under or in connection with the Contract.</p> <p>29.2 Any dispute between the Parties as to matters arising pursuant to this Contract which cannot be settled amicably within thirty (30) days after receipt by one Party of the other Party's request for such amicable settlement may be referred to Arbitration within 30 days after the expiration of amicable settlement period.</p>
30. Procedures for Disputes	<p>30.1 In case of arbitration, the arbitration shall be conducted in accordance with the arbitration procedures published by the Nepal Council of Arbitration (NEPCA) at the place given in the SCC.</p>
B. Staff and Labor	
31. Forced Labor	<p>31.1 The Contractor shall not employ forced labor, which consists of any work or service, not voluntarily performed, that is exacted from an individual under threat of force or penalty. This covers any kind of involuntary or compulsory labor, such as indentured labor, bonded labor, or similar labor–contracting arrangements.</p>
32. Child Labor	<p>32.1 The Contractor shall not employ children in a manner that is economically exploitative, or is likely to be hazardous, or to interfere with, the child's education, or to be harmful to the child's health or physical, mental, spiritual, moral, or social development. Where national laws have provisions for employment of minors, the Contractor shall follow those laws applicable to the Contractor. Children below the age of 18 years shall not be employed in dangerous work.</p>
33. Non-discrimination and Equal Opportunity	<p>34.1 The Contractor shall not make employment decisions on the basis of personal characteristics unrelated to inherent job requirements. The Contractor shall base the employment relationship on the principle of equal opportunity and fair treatment, and shall not discriminate with respect to aspects of the employment relationship, including recruitment and hiring, compensation (including wages and benefits), working conditions and terms of employment, access to training, promotion, termination of employment or retirement, and discipline. In countries where national law provides for non-discrimination in employment, the Contractor shall comply with national law. When national laws are silent on nondiscrimination in employment, the Contractor shall meet this Sub clause's requirements. Special measures of protection or assistance to remedy past discrimination or selection for a particular job based on the inherent requirements of the job shall not be deemed discrimination.</p>
B. Time Control	
34. Program	<p>34.1 Within the time stated in the SCC, after the date of the Letter of Acceptance, the Contractor shall submit to the Project Manager for approval a Program showing the general methods, arrangements, order, and timing for all the activities in the Works. In the case of a lump sum contract, the activities in the Program shall be consistent with those in the Activity Schedule.</p>

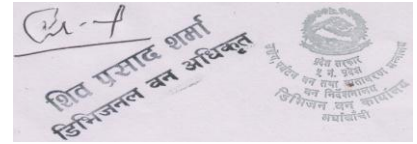

	<p>34.2 An update of the Program shall be a program showing the actual progress achieved on each activity and the effect of the progress achieved on the timing of the remaining work, including any changes to the sequence of the activities.</p> <p>34.3 The Contractor shall submit to the Project Manager for approval an updated Program at intervals no longer than the period stated in the SCC. If the Contractor does not submit an updated Program within this period, the Project Manager may withhold the amount stated in the SCC from the next payment certificate and continue to withhold this amount until the next payment after the date on which the overdue Program has been submitted. In the case of a lump sum contract, the Contractor shall Provide an updated Activity Schedule within 15 days of being instructed to by the Project Manager.</p> <p>34.4 The Project Manager's approval of the Program shall not alter the Contractor's obligations. The Contractor may revise the Program and submit it to the Project Manager again at any time. A revised Program shall show the effect of Variations and Compensation Events.</p>
<p>35. Extension of the Intended Completion Date</p>	<p>35.1 The Project Manager shall extend the Intended Completion Date if a Compensation Event occurs or a Variation is issued which makes it impossible for Completion to be achieved by the Intended Completion Date without the Contractor taking steps to accelerate the remaining work, which would cause the Contractor to incur additional cost.</p> <p>35.2 The Project Manager shall decide whether and by how much to extend the Intended Completion Date within 21 days of the Contractor asking the Project Manager for a decision upon the effect of a Compensation Event or Variation and submitting full supporting information at least 21 days prior to the intended completion date. If the Contractor has failed to give early warning of a delay or has failed to cooperate in dealing with a delay, the delay by this failure shall not be considered in assessing the new Intended Completion Date.</p>
<p>36. Acceleration</p>	<p>36.1 When the Employer wants the Contractor to finish before the Intended Completion Date, the Project Manager shall obtain priced proposals for achieving the necessary acceleration from the Contractor. If the Employer accepts these proposals, the Intended Completion Date shall be adjusted accordingly and confirmed by both the Employer and the Contractor.</p> <p>36.2 If the Contractor's priced proposals for acceleration are accepted by the Employer, they are incorporated in the Contract Price and treated as a Variation.</p>
<p>37. Delays Ordered by the Project Manager</p>	<p>37.1 The Project Manager may instruct the Contractor to delay the start or progress of any activity within the Works.</p>
<p>38. Management Meetings</p>	<p>38.1 Either the Project Manager or the Contractor may require the other to attend a management meeting. The business of a management meeting shall be to review the plans for remaining work and to deal with</p>

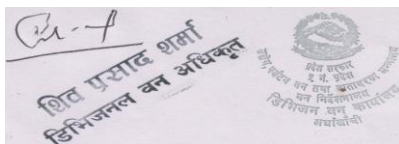

	<p>matters raised in accordance with the early warning procedure.</p> <p>38.2 The Project Manager shall record the business of management meetings and provide copies of the record to those attending the meeting and to the Employer. The responsibility of the parties for actions to be taken shall be decided by the Project Manager either at the management meeting or after the management meeting and stated in writing to all who attended the meeting.</p>
39. Early Warning	<p>39.1 The Contractor shall warn the Project Manager at the earliest opportunity of specific likely future events or circumstances that may adversely affect the quality of the work, increase the Contract Price, or delay the execution of the Works. The Project Manager may require the Contractor to provide an estimate of the expected effect of the future event or circumstance on the Contract Price and Completion Date. The estimate shall be provided by the Contractor as soon as reasonably possible.</p> <p>39.2 The Contractor shall cooperate with the Project Manager in making and considering proposals for how the effect of such an event or circumstance can be avoided or reduced by anyone involved in the work and in carrying out any resulting instruction of the Project Manager.</p>
C. Quality Control	
40. Identifying Defects	<p>40.1 The Project Manager shall check the Contractor's work and notify the Contractor of any Defects that are found. Such checking shall not affect the Contractor's responsibilities. The Project Manager may instruct the Contractor to search for a Defect and to uncover and test any work that the Project Manager considers may have a Defect.</p>
41. Tests	<p>41.1 If the Project Manager instructs the Contractor to carry out a test not specified in the Specification to check whether any work has a Defect and the test shows that it does, the Contractor shall pay for the test and any samples. If there is no Defect, the test shall be a Compensation Event.</p>
42. Correction of Defects	<p>42.1 The Project Manager shall give notice to the Contractor of any Defects before the end of the Defects Liability Period, which begins at Completion, and is defined in the SCC. The Defects Liability Period shall be extended for as long as Defects remain to be corrected.</p> <p>42.2 Every time notice of a Defect is given, the Contractor shall correct the notified Defect within the length of time specified by the Project Manager's notice.</p>
43. Uncorrected Defects	<p>43.1 If the Contractor has not corrected a Defect within the time specified in the Project Manager's notice, the Project Manager shall assess the cost of having the Defect corrected, and the Contractor shall pay this amount.</p>
D. Cost Control	
44. Contract Price	<p>44.1 In the case of a Unit Rate contract, the Bill of Quantities shall contain priced items for the Works to be performed by the Contractor. The Bill of Quantities is used to calculate the Contract Price. The Contractor will be paid for the quantity of the work accomplished at the</p>

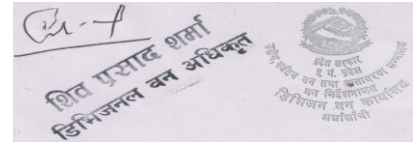

	<p>rate in the Bill of Quantities for each item.</p> <p>44.2 In the case of a lump sum contract, the Activity Schedule shall contain the priced activities for the Works to be performed by the Contractor. The Activity Schedule is used to monitor and control the performance of activities on which basis the Contractor will be paid. If payment for Materials on Site shall be made separately, the Contractor shall show delivery of Materials to the Site separately on the Activity Schedule.</p>
<p>45. Changes in the Contract Price</p>	<p>45.1 In the case of an Unit Rate contract:</p> <p>(a) If the final quantity of the work done differs from the quantity in the Bill of Quantities for the particular item by more than 25 percent, provided the change exceeds 2 percent of the Initial Contract Price, the Project Manager shall adjust the rate to allow for the change.</p> <p>(b) The Project Manager shall not adjust rates from changes in quantities if thereby the Initial Contract Price is exceeded by more than 10 percent, except with the prior approval of the Employer.</p> <p>(c) If requested by the Project Manager, the Contractor shall provide the Project Manager with a detailed cost breakdown of any rate in the Bill of Quantities.</p> <p>45.2 In the case of a lump sum contract, the Activity Schedule shall be amended by the Contractor to accommodate changes of Program or method of working made at the Contractor's own discretion. Prices in the Activity Schedule shall not be altered when the Contractor makes such changes to the Activity Schedule.</p>
<p>46. Variations</p>	<p>46.1 All Variations shall be included in updated Programs, and, in the case of a lump sum contract, also in the Activity Schedule, produced by the Contractor.</p> <p>46.2 The Contractor shall provide the Project Manager with a quotation for carrying out the Variation when requested to do so by the Project Manager. The Project Manager shall assess the quotation, which shall be given within seven (7) days of the request or within any longer period stated by the Project Manager and before the Variation is ordered.</p> <p>46.3 If the Contractor's quotation is unreasonable, the Project Manager may order the Variation and make a change to the Contract Price, which shall be based on the Project Manager's own forecast of the effects of the Variation on the Contractor's costs.</p> <p>46.4 If the Project Manager decides that the urgency of varying the work would prevent a quotation being given and considered without delaying the work, no quotation shall be given and the Variation shall be treated as a Compensation Event.</p> <p>46.5 The Contractor shall not be entitled to additional payment for costs that could have been avoided by giving early warning.</p> <p>46.6 In the case of an Unit Rate contract, if the work in the Variation corresponds to an item description in the Bill of Quantities and if, in the opinion of the Project Manager, the quantity of work above the limit stated in GCC 45.1 or the timing of its execution do not cause the cost</p>

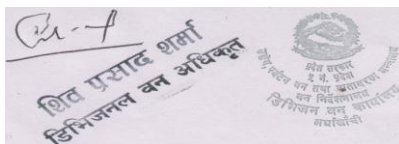

	<p>per unit of quantity to change, the rate in the Bill of Quantities shall be used to calculate the value of the Variation. If the cost per unit of quantity changes, or if the nature or timing of the work in the Variation does not correspond with items in the Bill of Quantities, the quotation by the Contractor shall be in the form of new rates for the relevant items of work.</p>
47. Cash Flow Forecasts	<p>47.1 When the Program, or, in the case of a lump sum contract, the Activity Schedule, is updated, the Contractor shall provide the Project Manager with an updated cash flow forecast.</p>
48. Payment Certificates	<p>48.1 The Contractor shall submit to the Project Manager monthly statements of the estimated value of the work executed less the cumulative amount certified previously.</p> <p>48.2 The Project Manager shall check the Contractor's monthly statement and certify the amount to be paid to the Contractor within 30 days of submission by contractor.</p> <p>48.3 The value of work executed shall be determined by the Project Manager.</p> <p>48.4 The value of work executed shall comprise:</p> <ul style="list-style-type: none"> (a) In the case of an Unit Rate contract, the value of the quantities of work in the Bill of Quantities that have been completed; or (b) In the case of a lump sum contract, the value of work executed shall comprise the value of completed activities in the Activity Schedule. <p>48.5 The value of work executed shall include the valuation of Variations and Compensation Events.</p> <p>48.6 The Project Manager may exclude any item certified in a previous certificate or reduce the proportion of any item previously certified in any certificate in the light of later information.</p>
49. Payments	<p>49.1 Payments shall be adjusted for deductions for advance payments and retention. The Employer shall pay the Contractor the amounts certified by the Project Manager within 30 days of the date of each certificate. If the Employer makes a late payment, the Contractor shall be paid interest as indicated in the SCC on the late payment in the next payment. Interest shall be calculated from the date by which the payment should have been made up to the date when the late payment is made.</p> <p>49.2 If an amount certified is increased in a later certificate or as a result of an award by an Arbitrator, the Contractor shall be paid interest upon the delayed payment as set out in this clause. Interest shall be calculated from the date upon which the increased amount would have been certified in the absence of dispute.</p> <p>49.3 Items of the Works for which no rate or price has been entered in BOQ shall not be paid for by the Employer and shall be deemed covered by other rates and prices in the Contract.</p>
50. Compensation	<p>50.1 The following shall be Compensation Events:</p>

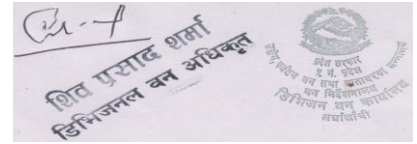

<p>Events</p>	<ul style="list-style-type: none"> (a) The Employer does not give access to a part of the Site by the Site Possession Date pursuant to GCC 26.1. (b) The Employer modifies the Schedule of Other Contractors in a way that affects the work of the Contractor under the Contract. (c) The Project Manager orders a delay or does not issue Drawings, Specifications, or instructions required for execution of the Works on time. (d) The Project Manager instructs the Contractor to uncover or to carry out additional tests upon work, which is then found to have no Defects. (e) The Project Manager unreasonably does not approve a subcontract to be let. (f) Ground conditions are substantially more adverse than could reasonably have been assumed before issuance of the Letter of Acceptance from the information issued to bidders (including the Site Investigation Reports), from information available publicly and from a visual inspection of the Site. (g) The Project Manager gives an instruction for dealing with an unforeseen condition, caused by the Employer, or additional work required for safety or other reasons. (h) Other contractors, public authorities, utilities, or the Employer does not work within the dates and other constraints stated in the Contract, and they cause delay or extra cost to the Contractor. (i) The advance payment is delayed. (j) The effects on the Contractor of any of the Employer's Risks. (k) The Project Manager unreasonably delays issuing a Certificate of Completion. <p>50.2 If a Compensation Event would cause additional cost or would prevent the work being completed before the Intended Completion Date, the Contract Price shall be increased and/or the Intended Completion Date shall be extended. The Project Manager shall decide whether and by how much the Contract Price shall be increased and whether and by how much the Intended Completion Date shall be extended.</p> <p>50.3 As soon as information demonstrating effect of each Compensation Event upon the Contractor's forecast cost has been provided by the Contractor, it shall be assessed by the Project Manager, and the Contract Price shall be adjusted accordingly. If the Contractor's forecast is deemed unreasonable, the Project Manager shall adjust the Contract Price based on the Project Manager's own forecast. The Project Manager shall assume that the Contractor shall react competently and promptly to the event.</p> <p>50.4 The Contractor shall not be entitled to compensation to the extent that the Employer's interests are adversely affected by the Contractor's not having given early warning or not having cooperated with the Project Manager.</p>
---------------	---

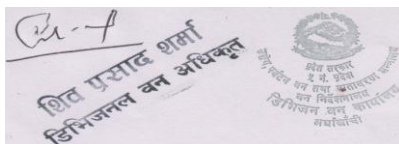

51. Tax	51.1 The Project Manager shall adjust the Contract Price if taxes, duties, and other levies are changed between the date 30 days before the submission of bids for the Contract and the date of the last Completion certificate. The adjustment shall be the change in the amount of tax payable by the Contractor, provided such changes are not already reflected in the Contract Price or are a result of GCC 53.
52. Currency	52.1 The currency of Contracts shall be Nepalese Rupees.
53. Price Adjustment	<p>53.1 Prices shall be adjusted for fluctuations in the cost of inputs only if provided for in the SCC. If so provided, the amounts certified in each payment certificate, before deducting for Advance Payment, shall be adjusted by applying the respective price adjustment factor to the payment amounts due.</p> <p>53.2 Adjustment Formulae³: The formulae will be of the following general type:</p> $pn = A + b \frac{Ln}{Lo} + c \frac{Mn}{Mo} + d \frac{En}{Eo} + etc.$ <p>Where:</p> <p><i>pn</i> is a price adjustment factor to be applied to the amount for the payment of the work carried out in the subject month, determined in accordance with Clause 49;</p> <p>A is a constant, specified in the Bidding Forms- Table of Price Adjustment data, representing the nonadjustable portion in contractual payments;⁴b, c, d, etc., coefficients representing the estimated proportion of each cost element (labor, materials, equipment usage, etc.) in the Works or sections thereof, net of Provisional Sums, as specified in the SCC;</p> <p><i>Ln, Mn, En, etc.</i>, are the current cost indices or reference prices of the cost elements for month “n,” determined pursuant to Sub-Clause 53.4, applicable to each cost element; and</p> <p><i>Lo, Mo, Eo, etc.</i>, are the base cost indices or reference prices corresponding to the above cost elements at the date specified in Sub-Clause 53.4</p>
	53.3 Sources of Indices and Weightings: The sources of indices shall be those listed in the Bidding Forms- Table of Price Adjustment data, as approved by the Project Manager and stated in SCC. Indices shall be appropriate for their purpose and shall relate to the Contractor’s proposed source of supply of inputs on the basis of which his Contract shall have been computed. As the proposed basis for price adjustment, the Contractor shall have submitted with his bid the

³ For complex Works involving several types of construction work with different inputs, a family of Formulae will be necessary. The various items of Day work may also require different formulae, depending on the nature and source of the inputs

⁴ Insert a figure for factor A only where there is a part of the Contractors’ expenditures which will not be subject to fluctuation in cost or to compensate for the unreliability of some indices. A should normally be 0.15. The sum of A, b, c, d, etc., should be one.

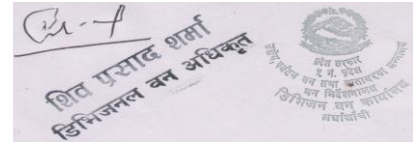

	<p>tabulation of Weightings and Source of Indices in the Bidding Forms, which shall be subject to approval by the Project Manager.</p> <p>53.4 Base, Current and Provisional Indices: The base cost indices or prices shall be those prevailing on the day 30 days prior to the latest date for submission of bids. Current indices or prices shall be those prevailing on the day 30 days prior to the last day of the period to which a particular Interim Payment Certificate is related. If at any time the current indices are not available, provisional indices as determined by the Project Manager will be used, subject to subsequent correction of the amounts paid to the Contractor when the current indices become available.</p> <p>53.5 Weightings: The weightings for each of the factors of cost given in the Bidding Forms shall be adjusted if, in the opinion of the Project Manager, they have been rendered unreasonable, unbalanced or inapplicable as a result of varied or additional work already executed or instructed under Clause 46 or for any other reason.</p>
	<p>53.6 Where, price adjustment provision is not applicable pursuant to Sub-clause 53.1 then the Contract is subject to price adjustment only for construction material in accordance with this clause. If the prices of the construction materials stated in the contract is increased or decreased in an unexpected manner in excess of ten (10%) percent in comparison to the base price construction material stated in Section –IV, Bidding Forms-Table of Price Adjustment Data, then the price adjustment for the increase or decrease of price of the construction material beyond 10% shall be made by applying the following formulas:</p> <p>For unexpected increase in price $P = [R_1 - (R_0 \times 1.10)] \times Q$</p> <p>For unexpected decrease in price P $= [R_1 - (R_0 \times 0.90)] \times Q$</p> <p>Where:</p> <p>“P” is price adjustment amount</p> <p>“R₁” is the present price of the construction material (Source of indices shall be those listed in the Bidding forms)</p> <p>“R₀” is the base price of the construction material</p> <p>“Q” is quantity of the construction material consumed in construction during the period of price adjustment consideration If the Base price and source is to be proposed by the Bidder as per the provision made in Section –IV, Bidding Forms-Table of Price Adjustment Data then the Base price and source filled by Bidder for the construction material stated in the Bidding Form shall be subject to the approval of the Project manager and shall be as stated in SCC..</p> <p>53.7 The Price Adjustment amount shall be limited to a maximum of the initial</p>

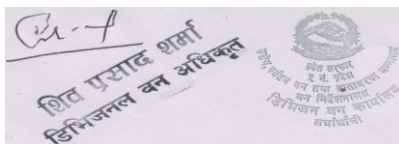

	<p>Contract Amount as specified in the SCC.</p> <p>53.8 The Price Adjustment provision shall not be applicable for delayed period if the contract is not completed in time due to the delay caused by the contractor or the contract is a Lump sum Contract</p>
54. Retention	<p>54.1 The Employer shall retain from each payment due to the Contractor the proportion stated in the SCC until Completion of the whole of the Works.</p> <p>54.2 Upon the issue of a Defects Liability Certificate by the Project Manager, in accordance with GCC 70.1, half the total amount retained shall be repaid to the Contractor and half when the Contractor has submitted the evidence of submission of tax return to the concerned Internal Revenue Office. On completion of the whole works, the Contractor may substitute retention money with an “on demand” bank guarantee.</p>
55. Liquidated Damages	<p>55.1 The Contractor shall pay liquidated damages to the Employer at the rate per day stated in the SCC for each day that the Completion Date is later than the Intended Completion Date. The total amount of liquidated damages shall not exceed the amount defined in the SCC. The Employer may deduct liquidated damages from payments due to the Contractor. Payment of liquidated damages shall not affect the Contractor’s liabilities.</p> <p>55.2 If the Intended Completion Date is extended after liquidated damages have been paid, the Project Manager shall correct any overpayment of liquidated damages by the Contractor by adjusting the next payment certificate. The Contractor shall be paid interest on the overpayment, calculated from the date of payment to the date of repayment, at the rates specified in GCC.49</p>
56. Bonus	<p>56.1 The Contractor shall be paid a Bonus calculated at the rate per calendar day stated in the SCC for each day (less any days for which the Contractor is paid for acceleration) that the Completion is earlier than the Intended Completion Date. The Project Manager shall certify that the Works are complete, although they may not be due to be complete.</p>
57. Advance Payment	<p>57.1 The Employer shall make advance payment to the Contractor of the amounts stated in the SCC in two equal installments by the date stated in the SCC, against provision by the Contractor of an unconditional bank guarantee from Commercial Bank or Financial Institution eligible to issue Bank Guarantee as per prevailing Law in Nepal, in a form acceptable to the Employer in amounts equal to the advance payment. The guarantee shall remain effective until the advance payment has been repaid, but the amount of the guarantee shall be progressively reduced by the amounts repaid by the Contractor. Interest shall not be charged on the advance payment.</p> <p>57.2 The Contractor is to use the advance payment only to pay for</p>

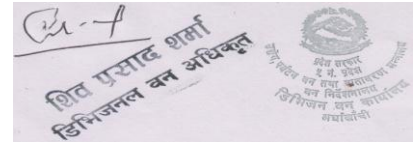

	<p>Equipment, Plant, Materials, and mobilization expenses required specifically for execution of the Contract. The Contractor shall demonstrate that advance payment has been used in this way by supplying copies of invoices or other documents to the Project Manager.</p> <p>57.3 The advance payment shall be repaid by deducting proportionate amounts, as stated in SCC, from payments otherwise due Contractor, following the schedule of completed percentages of the Works on a payment basis. No account shall be taken of the advance payment or its repayment in assessing valuations of work done, Variations, price adjustments, Compensation Events, Bonuses, or Liquidated Damages.</p>
58. Securities	<p>58.1 The Performance Security, including any additional security required as per ITB 35.5 and ITB 40.1, shall be provided to the Employer no later than the date specified in the Letter of Acceptance and shall be issued in an amount specified in the SCC, by a Commercial Bank or Financial Institution eligible to issue Bank Guarantee as per prevailing Law in Nepal. acceptable to the Employer, and denominated in Nepalese Rupees. The Performance Security shall be valid until a date 30 days from the date of issue of the Defect Liability Certificate in the case of a bank guarantee.</p> <p>Any additional performance security required as per ITB 35.5 shall be valid until a date 30 days from the date of issue of the certificate of Completion in the case of a bank guarantee.</p> <p>Any additional performance security required as per ITB 40.1 shall be valid until a date 30 days from the date of issue of the certificate of DLP in the case of a bank guarantee.</p> <p>58.2 The performance security issued by any foreign Bank outside Nepal must be counter guaranteed by Commercial Bank or Financial Institution eligible to issue Bank Guarantee as per prevailing Law in Nepal.</p>
59. Day works	<p>59.1 If applicable, the Day works rates in the Contractor's Bid shall be used for small additional amounts of work only when the Project Manager has given written instructions in advance for additional work to be paid for in that way.</p> <p>59.2 All work to be paid for as Day works shall be recorded by the Contractor on forms approved by the Project Manager. Each completed form shall be verified and signed by the Project Manager within two days of the work being done.</p> <p>59.3 The Contractor shall be paid for Day works subject to obtaining signed Day works forms.</p>
60. Cost of Repairs	<p>60.1 Loss or damage to the Works or Materials to be incorporated in the Works between the Start Date and the end of the Defects Correction periods shall be remedied by the Contractor at the Contractor's cost if the loss or damage arises from the Contractor's acts or omissions.</p>
F. Force Majeure	

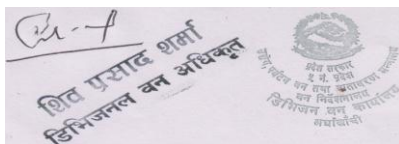

<p>61. Definition of Force Majeure</p>	<p>61.1 In this Clause, “Force Majeure” means an exceptional event or circumstance,</p> <ul style="list-style-type: none"> (a) which is beyond a Party’s control; (b) which such Party could not reasonably have provided against before entering into the Contract; (c) which, having arisen, such Party could not reasonably have avoided or overcome; and (d) which is not substantially attributable to the other Party.
	<p>61.2 Force Majeure may include, but is not limited to, exceptional events or circumstances of the kind listed below, so long as conditions (a) to (d) above are satisfied:</p> <ul style="list-style-type: none"> (a) war, hostilities (whether war be declared or not), invasion, act of foreign enemies; (b) rebellion, terrorism, sabotage by persons other than the Contractor’s Personnel, revolution, insurrection, military or usurped power, or civil war; (c) riot, commotion, disorder, strike or lockout by persons other than the Contractor’s Personnel; (d) munitions of war, explosive materials, ionizing radiation or contamination by radio-activity, except as may be attributable to the Contractor’s use of such munitions, explosives, radiation or radio-activity; and (e) natural catastrophes such as earthquake, hurricane, typhoon or volcanic activity.
<p>62. Notice of Force Majeure</p>	<p>62.1 If a Party is or will be prevented from performing its substantial obligations under the Contract by Force Majeure, then it shall give notice to the other Party of the event or circumstances constituting the Force Majeure and shall specify the obligations, the performance of which is or will be prevented. The notice shall be given within 14 days after the Party became aware, or should have become aware, of the relevant event or circumstance constituting Force Majeure.</p> <p>62.2 The Party shall, having given notice, be excused performance of its obligations for so long as such Force Majeure prevents it from performing them.</p> <p>62.3 Notwithstanding any other provision of this Clause, Force Majeure shall not apply to obligations of either Party to make payments to the other Party under the Contract.</p>
<p>63. Duty to</p>	<p>63.1 Each Party shall at all times use all reasonable endeavors to minimize</p>

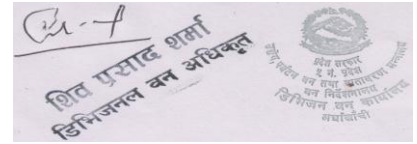

Minimize Delay	<p>any delay in the performance of the Contract as a result of Force Majeure.</p> <p>63.2 A Party shall give notice to the other Party when it ceases to be affected by the Force Majeure.</p>
64. Consequences of Force Majeure	<p>64.1 If the Contractor is prevented from performing its substantial obligations under the Contract by Force Majeure of which notice has been given under GCC 62, and suffers delay and/or incurs Cost by reason of such Force Majeure, the Contractor shall be entitled subject to GCC 30 to</p> <ul style="list-style-type: none"> (a) an extension of time for any such delay, if completion is or will be delayed, under GCC35 ; and (b) if the event or circumstance is of the kind described in subparagraphs (a) to (d) of GCC 61.2 and, in the case of subparagraphs (b) to (d), occurs in the Country, payment of any such Cost, including the costs of rectifying or replacing the Works and/or Goods damaged or destroyed by Force Majeure, to the extent they are not indemnified through the insurance policy referred to in GCC 19. <p>64.2 After receiving this notice, the Project Manager shall proceed in accordance with GCC 10 to agree or determine these matters.</p>
65. Force Majeure Affecting Subcontractor	<p>65.1 If any Subcontractor is entitled under any contract or agreement relating to the Works to relief from force majeure on terms additional to or broader than those specified in this Clause, such additional or broader force majeure events or circumstances shall not excuse the Contractor's nonperformance or entitle him to relief under this Clause.</p>
66. Optional Termination, Payment and Release	<p>66.1 If the execution of substantially all the Works in progress is prevented for a continuous period of 90 days by reason of Force Majeure of which notice has been given under GCC 62, or for multiple periods which total more than 150 days due to the same notified Force Majeure, then either Party may give to the other Party a notice of termination of the Contract. In this event, the termination shall take effect 7 days after the notice is given, and the Contractor shall proceed in accordance with GCC 72.5.</p> <p>66.2 Upon such termination, the Project Manager shall determine the value of the work done and issue a Payment Certificate, which shall include</p> <ul style="list-style-type: none"> (a) the amounts payable for any work carried out for which a price is stated in the Contract; (b) the Cost of Plant and Materials ordered for the Works which have been delivered to the Contractor, or of which the Contractor is liable to accept delivery: this Plant and Materials shall become

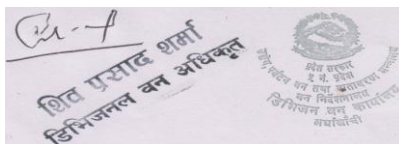

	<p>the property of (and be at the risk of) the Employer when paid for by the Employer, and the Contractor shall place the same at the Employer's disposal;</p> <p>(c) other Costs or liabilities which in the circumstances were reasonably and necessarily incurred by the Contractor in the expectation of completing the Works;</p> <p>(d) the Cost of removal of Temporary Works and Contractor's Equipment from the Site and the return of these items to the Contractor's works in his country (or to any other destination at no greater cost); and</p> <p>(e) the Cost of repatriation of the Contractor's staff and labor employed wholly in connection with the Works at the date of termination.</p>
67. Release from Performance	<p>67.1 Notwithstanding any other provision of this Clause, if any event or circumstance outside the control of the Parties (including, but not limited to, Force Majeure) arises, which makes it impossible or unlawful for either or both Parties to fulfill its or their contractual obligations or which, under the law governing the Contract, entitles the Parties to be released from further performance of the Contract, then upon notice by either Party to the other Party of such event or circumstance,</p> <p>(a) the Parties shall be discharged from further performance, without prejudice to the rights of either Party in respect of any previous breach of the Contract; and</p> <p>(b) the sum payable by the Employer to the Contractor shall be the same as would have been payable under GCC 66 if the Contract had been terminated under GCC 66.</p>
G. Finishing the Contract	
68. Completion	<p>68.1 The Contractor shall request the Project Manager to issue a certificate of Completion of the Works, and the Project Manager shall do so upon deciding that the work is completed.</p> <p>68.2 In addition to the other provisions, before acceptance of the completed works, Employer shall verify and assure that such works are within the set objective, quality and appropriate to operate and use.</p>
69. Taking Over	<p>69.1 The Employer shall take over the Site and the Works within seven days of the Project Manager's issuing a certificate of Completion.</p>
70. Final Account	<p>70.1 The Contractor shall supply the Project Manager with a detailed account of the total amount that the Contractor considers payable under the Contract before the end of the Defects Liability Period. The Project Manager shall issue a Defects Liability Certificate and certify any final payment that is due to the Contractor within 60 days of receiving the Contractor's account if it is correct and complete. If it is not, the Project Manager shall issue within 60 days a schedule that states</p>

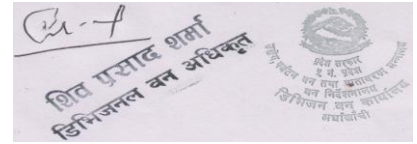

	<p>the scope of the corrections or additions that are necessary. If the Final Account is still unsatisfactory after it has been resubmitted, the Project Manager shall decide on the amount payable to the Contractor and issue a payment certificate.</p>
<p>71. Operating and Maintenance Manuals</p>	<p>71.1 If “as built” Drawings and/or operating and maintenance manuals are required, the Contractor shall supply them by the dates stated in the SCC.</p> <p>71.2 If the Contractor does not supply the Drawings and/or manuals by the dates stated in the SCC pursuant to GCC 71.1, or they do not receive the Project Manager’s approval, the Project Manager shall withhold the amount stated in the SCC from payments due to the Contractor.</p>
<p>72. Termination</p>	<p>72.1 The Employer may terminate the Contract at any time if the contractor;</p> <ol style="list-style-type: none"> a. does not commence the work as per the Contract, b. abandons the work without completing, c. fails to achieve progress as per the Contract. <p>72.2 The Employer or the Contractor may terminate the Contract if the other party causes a fundamental breach of the Contract.</p> <p>72.3 Fundamental breaches of Contract shall include, but shall not be limited to, the following :</p> <ol style="list-style-type: none"> (a) The Contractor uses the advance payment for matters other than the contractual obligations, (b) the Contractor stops work for 30 days when no stoppage of work is shown on the current Program and the stoppage has not been authorized by the Project Manager; (c) the Project Manager instructs the Contractor to delay the progress of the Works, and the instruction is not withdrawn within 30 days; (d) the Employer or the Contractor is made bankrupt or goes into liquidation other than for a reconstruction or amalgamation. (e) a payment certified by the Project Manager is not paid by the Employer to the Contractor within 90 days of the date of the Project Manager’s certificate; (f) the Project Manager gives Notice that failure to correct a particular Defect is a fundamental breach of Contract and the Contractor fails to correct it within a reasonable period of time determined by the Project Manager; (g) the Project Manager gives two consecutive Notices to update the Program and accelerate the works to ensure compliance with GCC Sub clause 22.1 and the Contractor fails to update the Program and demonstrate acceleration of the works within a reasonable period of time determined by the Project Manager; (h) the Contractor does not maintain a Security, which is required; (i) the Contractor has delayed the completion of the Works by the number of days for which the maximum amount of liquidated damages can be paid, as defined in the SCC; and

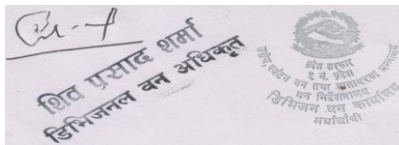

	<p>(j) If the Contractor, in the judgment of the Employer has engaged in corrupt or fraudulent practices in competing for or in executing the Contract, pursuant to GCC 73.1.</p> <p>72.4 When either party to the Contract gives notice of a breach of Contract to the Project Manager for a cause other than those listed under GCC 72.3 above, the Project Manager shall decide whether the breach is fundamental or not.</p> <p>72.5 Notwithstanding the above, the Employer may terminate the Contract for convenience.</p> <p>72.6 If the Contract is terminated, the Contractor shall stop work immediately, make the Site safe and secure, and leave the Site as soon as reasonably possible.</p>
<p>73. Fraud and Corruption</p>	<p>73.1 If the Employer determines that the Contractor has engaged in corrupt, fraudulent, collusive, coercive or obstructive practices, in competing for or in executing the Contract, then the Employer may, after giving 15 days notice to the Contractor, terminate the Contractor's employment under the Contract and expel him from the Site.</p> <p>73.2 Should any employee of the Contractor be determined to have engaged in corrupt, fraudulent, collusive, coercive, or obstructive practice during the execution of the Works, then that employee shall be removed in accordance with GCC Clause 15.</p> <p>For the purposes of this GCC 73;</p> <p>(i) "corrupt practice" is the offering, giving, receiving or soliciting, directly or indirectly, of anything of value to influence improperly the actions of another party.</p> <p>(ii) "fraudulent practice"⁵ is any act or omission, including a misrepresentation, that knowingly or recklessly misleads, or attempts to mislead, a party to obtain a financial or other benefit or to avoid an obligation;</p> <p>(iii) "collusive practice"⁶ is an arrangement between two or more parties designed to achieve an improper purpose, including to influence improperly the actions of another party;</p> <p>(iv) "coercive practice"⁷ is impairing or harming, or threatening to impair or harm, directly or indirectly, any party or the property of the party to influence improperly the actions of a party;</p> <p>(v) "obstructive practice" is</p> <p>(aa) deliberately destroying, falsifying, altering or concealing of evidence material to the investigation or making false statements to investigators in order to materially impede a investigation into allegations of a corrupt, fraudulent, coercive or collusive practice; and/or threatening, harassing or intimidating any party to prevent it from disclosing its knowledge of matters relevant to the investigation or from pursuing the investigation; or</p> <p>(bb) acts intended to materially impede the exercise of the GON's/DP's inspection and audit rights provided for under</p>

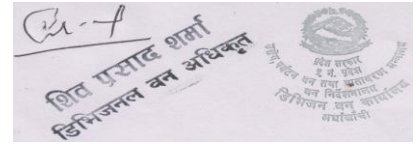

	GCC28.3.
74. Black Listing	<p>74.1 Without prejudice to any other rights of the Employer under this Contract, GoN, Public Procurement Monitoring Office (PPMO), on the recommendation of procuring entity, may blacklist a Bidder for its conduct for a period of one (1) to three (3) years on the following grounds and seriousness of the act committed by the bidder:</p> <p>(a) if it is established that the Contractor has committed substantial defect in implementation of the contract or has not substantially fulfilled its obligations under the contract or the completed work is not of the specified quality as per the contract.</p> <p>(b) If convicted from a court of law in a criminal offense liable to be disqualified for taking part in procurement contract,</p> <p>(c) If it is established that the Contractor has engaged in corrupt or fraudulent practices in competing for or in executing the Contract.</p>
75. Payment upon Termination	<p>75.1 If the Contract is terminated because of a fundamental breach of Contract by the Contractor, the Project Manager shall issue a certificate for the value of the work done and Materials ordered less advance payments received up to the date of the issue of the certificate. Additional Liquidated Damages shall not apply. If the total amount due to the Employer exceeds any payment due to the Contractor, the difference shall be a debt payable to the Employer.</p> <p>75.2 If the Contract is terminated for the Employer's convenience or because of a fundamental breach of Contract by the Employer, the Project Manager shall issue a certificate for the value of the work done, Materials ordered, the reasonable cost of removal of Equipment, repatriation of the Contractor's personnel employed solely on the Works, and the Contractor's costs of protecting and securing the Works, and less advance payments received up to the date of the certificate.</p> <p>75.3 If the Contract is terminated because of fundamental breach of Contract or for any other fault by the Contractor, the performance security shall be forfeited by the Employer.</p> <p>In such case, amount to complete the remaining works as per the Contract shall be recovered from the Contractor as Government dues.</p>
76. Property	<p>76.1 All Materials on the Site, Plant, Equipment, Temporary Works, and Works shall be deemed to be the property of the Employer if the Contract is terminated because of the Contractor's default.</p>
77. Release from Performance	<p>77.1 If the Contract is frustrated by the outbreak of war or by any other event entirely outside the control of either the Employer or the Contractor, the Project Manager shall certify that the Contract has been frustrated. The Contractor shall make the Site safe and stop work as quickly as possible after receiving this certificate and shall be paid for all work carried out before receiving it and for any work carried out afterwards to which a commitment was made.</p>

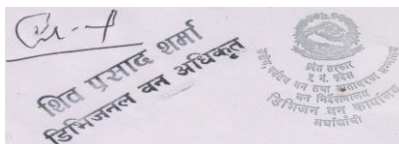

<p>78. Suspension of DP Loan/Credit/Grant</p>	<p>78.1 In the event that the DP suspends the loan/ credit/grant to the Employer from which part of the payments to the Contractor are being made:</p> <ul style="list-style-type: none"> a. the Employer is obligated to notify the Contractor of such suspension within 7 days of having received the DP's suspension notice; and b. if the Contractor has not received sums due him within the 30 days for payment provided for in GCC 49.1, the Contractor may immediately issue a 15-day termination notice.
<p>79. Eligibility</p>	<p>79.1 The Contractor shall have the nationality of an eligible country as specified in Section V of the bidding document. The Contractor shall be deemed to have the nationality of a country if the Contractor is a citizen or is constituted, or incorporated, and operates in conformity with the provisions of the laws of that country. This criterion shall also apply to the determination of the nationality of proposed subcontractors or suppliers for any part of the Contract including related services.</p> <p>79.2 The materials, equipment, and services to be supplied under the Contract shall have their origin in eligible source countries as specified in Section V of the bidding document and all expenditures under the Contract will be limited to such materials, equipment, and services. At the Employer's request, the Contractor may be required to provide evidence of the origin of materials, equipment, and services.</p> <p>79.3 For purposes of GCC 79.2, "origin" means the place where the materials and equipment are mined, grown, produced, or manufactured, and from which the services are provided. Materials and equipment are produced when, through manufacturing, processing, or substantial or major assembling of components, a commercially recognized product results that differs substantially in its basic characteristics or in purpose or utility from its components.</p>
<p>80. Project Manager's Duties and Authorities</p>	<p>80.1 The Project Manager's duties and authorities are restricted to the extent as stated in the SCC.</p>
<p>81. Quarries and Spoil Dumps</p>	<p>81.1 Any quarry operated as part of this Contract shall be maintained and left in a stable condition without steep slopes and be either refilled or drained and be landscaped by appropriate planting. Rock or gravel taken from a river shall be removed over some distance so as to limit the depth of material removed at any one location, not disrupt the river flow or damage or undermine the river banks. The Contractor shall not deposit excavated material on land in Government or private ownership except as directed by the Project Manager in writing or by permission in writing of the authority responsible for such land in Government ownership, or of the owner or responsible representative of the owner of such land in private ownership, and only then in those places and under such conditions as the authority, owner or responsible representative may prescribe.</p>
<p>82. Local Taxation</p>	<p>82.1 The prices bid by the Contractor shall include all taxes that may be</p>

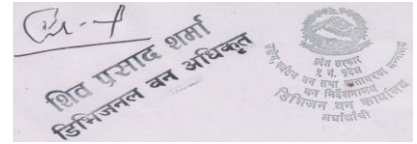

	<p>levied in accordance to the laws and regulations in being in Nepal on the date 30 days prior to the closing date for submissions of Bids on the Contractor's equipment, plant and materials acquired for the purpose of the Contract and on the services performed under the Contract. Nothing in the Contract shall relieve the Contractor from his responsibility to pay any tax that may be levied in Nepal on profits made by him in respect of the Contract.</p>
83. Value Added Tax	83.1 The Contract is not exempted from value added tax. An amount specified in the schedule of taxes shall be paid by the Contractor in the concerned VAT office within time frame specified in VAT regulation.
84. Income Taxes on Staff	<p>84.1 The Contractor's staff, personnel and labor will be liable to pay personal income taxes in Nepal in respect of their salaries and wages, as are chargeable under the laws and regulations for the time being in force, and the Contractor shall perform such duties in regard to such deductions as may be imposed on him by such laws and regulations.</p> <p>84.2 The issue of the Final Account Certificate pursuant to clause GCC 70 shall be made only upon submittal by the Contractor of a certificate of income tax clearance from the Government of Nepal.</p>
85. Duties, Taxes and Royalties	<p>85.1 Any element of royalty, duty or tax in the price of any goods including fuel oil, and lubricating oil, cement, timber, iron and iron goods locally procured by the Contractor for the works shall be included in the Contract rates and prices and no reimbursement or payment in that respect shall be made to the Contractor.</p> <p>85.2 The Contractor shall familiarize himself with GON the rules and regulations with regard to customs, duties, taxes, clearing of goods and equipment, immigration and the like, and it will be necessary for him to follow the required procedures regardless of the assistance as may be provided by the Employer wherever possible.</p> <p>85.3 The Contractor shall pay and shall not be entitled to the reimbursement of cost of extracting construction materials such as sand, stone/boulder, gravel, etc. from the river beds or quarries. Such prices will be levied by the local District Development Committee (DDC) as may be in force at the time. The Contractor, sub-contractor(s) employed directly by him and for whom he is responsible, will not be exempted from payment of royalties, taxes or other kinds of surcharges on these construction materials so extracted and paid for to the DDC.</p>
86. Member of Government, etc, not Personally Liable	86.1 No member or officer of GoN or the Employer or the Project Manager or any of their respective employees shall be in any way personally bound or liable for the act or obligations of the Employer under the Contract or answerable for any default or omission in the observance or performance of any of act, matter or thing which are herein contained.
87. Approval of Use of Explosives	87.1 No explosives of any kind shall be used by the Contractor without the prior consent of the Employer in writing and the Contractor shall provide, store and handle these and all other items of every kind whatsoever required for blasting operations, all at his own expense in a manner approved in writing by the Employer.

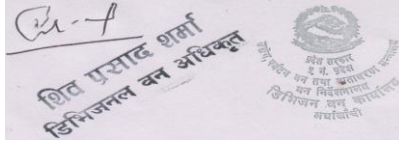

<p>88 Compliance with Regulations for Explosives</p>	<p>88.1 The Contractor shall comply with all relevant ordinances, instructions and regulations which the Government, or other person or persons having due authority, may issue from time to time regarding the handling, transportation, storage and use of explosives.</p>
<p>89. Permission for Blasting</p>	<p>89.1 The Contractor shall at all times maintain full liaison with and inform well in advance, and obtain such permission as is required from all Government authorities, public bodies and private parties whatsoever concerned or affected, or likely to be concerned or affected by blasting operation.</p>
<p>90. Records of Explosives</p>	<p>90.1 Before the beginning of the Defects Liability Period, the Contractor shall account to the satisfaction of the Project Manager for all explosives brought on to the Site during the execution of the Contract and the Contractor shall remove all unused explosives from the Site on completion of works when ordered by the Project Manager.</p>
<p>91. Traffic Diversion</p>	<p>91.1 The Contractor shall include the necessary safety procedures regarding and pedestrian traffic diversion that is needed in execution of the works. The Contractor shall include in his costing of works, any temporary works or diversion that are needed during the construction period. All traffic diversion should be designed for the safety of both the motoring public and the men at work. It shall ensure the uninterrupted flow of traffic and minimum inconvenience to the public during the period concerned. As such, adequate warning signs, flagmen and other relevant safety precautionary measures shall be provided to warn motorists and pedestrians well ahead of the intended diversion as directed by the Project Manager. All traffic devices used shall be designed in accordance with the instruction of Project Manager.</p>

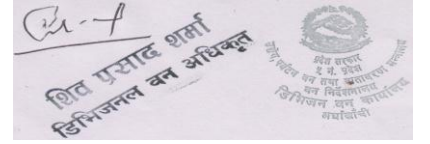

Section IX: Special Conditions of Contract

The following Special Conditions of Contract shall supplement the GCC. Whenever there is a conflict, the provisions herein shall prevail over those in the GCC

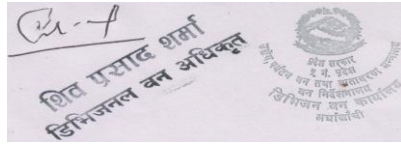

Special Conditions of Contract

A. General	
GCC 1.1 (q)	The Employer is Division Forest office , Arghakhanchi
GCC 1.1 (v)	The Intended Completion Date for the whole of the Works shall be 14-06-2021 <i>[If different dates are specified for completion of the Works by section("sectional completion" or milestones), these dates should be listed here]</i>
GCC 1.1(bb) & 10.1	The Project Manager is Shiva Prasad Sharma The Project Manager and Engineer are synonyms.
GCC 1.1 (ee)	The Site is located at Panini, Arghakhanchi
GCC 1.1 (hh)	The Start Date shall be 06-04-2020
GCC 1.1 (ll)	The Works consist of Construction of Auditorium Hall
GCC 2.2	Sectional Completions are: N/A
GCC 2.3(i)	The following documents also form part of the Contract N/A
GCC 3.1	The language of the contract is ENGLISH/NEPALI The law that applies to the Contract is the law of NEPAL
GCC 11.1	The Project Manager <i>may</i> delegate any of his duties and responsibilities.
GCC 13.1	<p>Qualification Criteria</p> <p>The proposed sub-contractor shall meet the following requirements:</p> <ol style="list-style-type: none"> 1) Completion of 80% of the quantity of the work being sub contracted 2) Average Annual Construction Turnover for the work being sub contracted should be at least $1.5 * V/T$ where V is the proposed value of sub contract and T is time in year. For contract duration of up to 1 year, T shall be "1". <p>Financial Resources: The sub contract must demonstrate that it has the financial resources to meet its current contract commitment plus three months' requirements for the sub contracted work.</p>
GCC 14.1	Schedule of other contractors: must submit monthly

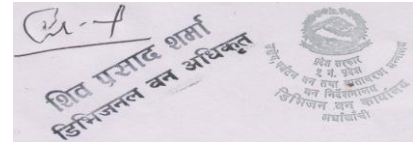

GCC 19.1	<p>The minimum insurance amounts and deductibles shall be:</p> <ol style="list-style-type: none"> 1. The minimum cover for loss of or damage to the Works, Plant and Materials is: 0.5 percent of the Contract Amount. 2. The maximum deductible for insurance of the Works and of Plant and Materials is: 0.5 percent of the Contract Amount. 3. The minimum cover for loss or damage to Equipment is : 0 4. The maximum deductible for insurance of Equipment is: 0 5. The minimum for insurance of other property is: 0 with unlimited number of occurrences 6. The maximum deductible for insurance of other property is: 0
GCC 20.1	Site Investigation Reports are: As required by the employee
GCC 23.1	The following shall be designed by the Contractor: Labor Camp , Site Camp
GCC 26.1	The Site Possession Date(s) shall be: 30-03-2020
GCC 30.1	The place of arbitration shall be: Division Forest Office
C. Time Control	
GCC 34.1	The Contractor shall submit for approval a Program for the Works within 15 days from the date of the Letter of Acceptance.
GCC 34.3	<p>The period between Program updates is 30 days.</p> <p>The amount to be withheld for late submission of an updated Program is 15000</p>
D. Quality Control	
GCC 42.1	The Defects Liability Period is: 365 days
E. Cost Control	
GCC 49.1	As per Nepal Rastra Bank
GCC 53.1	<p>The Contract is not subjected to price adjustment, and the following information regarding coefficients "does not" apply.</p> <p>The coefficients and indices for adjustment of prices in Nepalese Rupees shall be as specified in the Table of Adjustment Data submitted by bidder together with the Letter of Price Bid which is approved by the Project manager.</p>

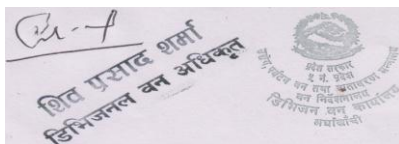

GCC 53.6	Base Price of Construction Materials applicable for price adjustment shall be as per the Table of Adjustment Data submitted by Bidder together with the Letter of Price Bid which is approved by the Project manager.
GCC 53.7	The Price Adjustment amount shall be limited to a maximum of: For GoN Funded percentage of the initial Contract Amount is 25 % For DP Funded: Not Applicable
GCC 54.1	The proportion of payments retained is: For GoN Funded: 5 (five) percent
GCC 55.1	The liquidated damages for the whole of the Works are 0.05 Percent of the final Contract Price per day. The maximum amount of liquidated damages for the whole of the Works is 10 Percent of the final Contract Price.
GCC 56.1	The Bonus for the whole of the Works is 0.05 Percent per day. The maximum amount of Bonus for the whole of the Works is 0 of the final Contract Price.
GCC 57.1	The Advance Payments shall be: 20% and shall be paid in two equal installments and to the Contractor.
GCC 57.3	Deductions from Payment Certificates will commence in the first certificate in which the value of works executed exceeds 30% of the Contract Price. Deduction will be at the rate of [Insert percentage] ¹ of the respective Monthly Interim Payment Certificate until such time as the advance payment has been repaid; provided that the advance payment shall be completely repaid prior to the end of 80 % of the approved contract period.
GCC 58.1	The Performance Security amount is: amount including an additional amount based on ITB 40.1 and/or ITB 35.5 if the Employer has increased the Performance Security amount
G. Finishing the Contract	
GCC 71.1	The date by which operating and maintenance manuals are required is; 06-05-2020
GCC 71.2	The date by which “as built” drawings are required is: 10-05-2020 The amount to be withheld for failing to produce “as built” drawings and/or Operating and maintenance manuals is: 15000
GCC 72.3 (i)	The maximum number of days is: 200
GCC 80	The Project Manager has to obtain the specific approval of the Employer for taking any of the following actions : a. Approving subcontracting of any part of the works under General

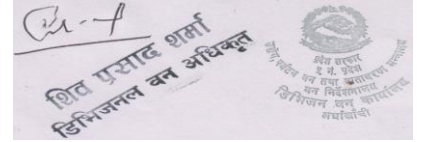

	<p>Conditions of Contract Clause 13;</p> <ul style="list-style-type: none">b. Certifying additional costs determined under General Conditions of Contract Clause 50;c. Determining start date under General Conditions of Contract Clause 1;d. Determining the extension of the intended Completion Date under General Conditions of Contract Clause 35;e. Issuing a Variation under General Conditions of Contract Clause 1 and 46, except in an emergency situation, as reasonably determined by the Project Manager; emergency situation may be defined as the situation when protective measures must be taken for the safety of life or of the works or of adjoining property.f. Adjustment of rates under General Conditions of Contract Clause 45;
--	---

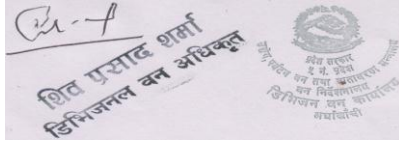

Section X: Contract Forms

This Section contains forms which, once completed, will form part of the Contract. The forms for Performance Security and Advance Payment Security, when required, shall only be completed by the successful Bidder after contract award.

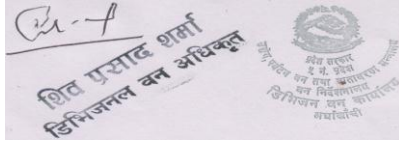

Letter of Acceptance [on letterhead paper of the Employer]

Date:

To: **Name and address of the Contractor**.....

Subject: **Notification of Award**

This is to notify that your Bid dated **date**for execution of the.....**name of the contract and identification number, as given in the Contract Data/SCC** for the Contract price of Nepalese Rupees [**insert amount in figures and words in Nepalese Rupees**], as corrected in accordance with the Instructions to Bidders is hereby accepted in accordance with the Instruction to Bidders.

You are hereby instructed to contact this office to sign the formal contract agreement within 15 days with Performance Security of **NRs.** in accordance with the Conditions of Contract, using for that purpose the Performance security Form included in Section X (Contract Forms) of this Bidding Document.

Authorized Signature:

Name and Title of Signatory:

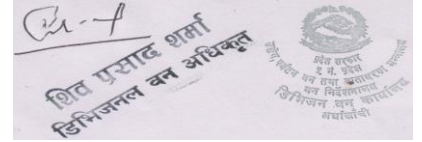

Contract Agreement

THIS AGREEMENT made theday of.....between..... name of the Employer(**hereinafter “the Employer”**), of the one part, andname of the Contractor(**hereinafter “the Contractor”**), of the other part:

WHEREAS the Employer desires that the Works known as name of the Contractshould be executed by the Contractor, and has accepted a Bid by the Contractor for the execution and completion of these Works and the remedying of any defects in the sum of NRs**[insert amount of contract price in words and figures including taxes]**(hereinafter “the Contract Price”).

The Employer and the Contractor agree as follows:

1. In this Agreement words and expressions shall have the same meanings as are respectively assigned to them in the Contract documents referred to.
2. The following documents shall be deemed to form and be read and construed as part of this Agreement. This Agreement shall prevail over all other Contract documents.
 - (a) the Letter of Acceptance;
 - (b) the Letters of Technical and Price Bid;
 - (c) the Addenda Nos **Insert addenda numbers if any**
 - (d) the Special Conditions of Contract;
 - (e) the List of Eligible Countries that was specified in Section V of the bidding document,
 - (f) the General Conditions of Contract;
 - (g) the Specification;
 - (h) the Drawings;
 - (i) Bill of Quantities (or Schedules of Prices for lump sum contracts), and
 - (j) Table of Price Adjustment Data
 - (k) List of Approved Subcontractors *[For GoN funded project]*
 - (l)**[Specify if there are any other document]**
3. In consideration of the payments to be made by the Employer to the Contractor as indicated in this Agreement, the Contractor hereby covenants with the Employer to execute the Works and to remedy defects therein in conformity in all respects with the provisions of the Contract.
4. The Employer hereby covenants to pay the Contractor in consideration of the execution and completion of the Works and the remedying of defects therein, the Contract Price or such other sum as may become payable under the provisions of the Contract at the times and in the manner prescribed by the Contract.

IN WITNESS whereof the parties hereto have caused this Agreement to be executed in accordance with the laws of Nepal on the day, month and year indicated above.

Signed by
for and on behalf the Contractor in the presence of

Witness, Name Signature, Address, Date

Signed by.....
for and on behalf of the Employer in the presence of

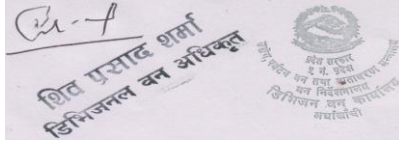

Witness, Name, Signature, Address, Date

List of Approved Subcontractors

In accordance with GCC Sub-Clause 13.1, The following Subcontractors are approved for carrying out the work as specified below.

Name of Subcontractors	Description of Works	Value/Percentage of subcontract

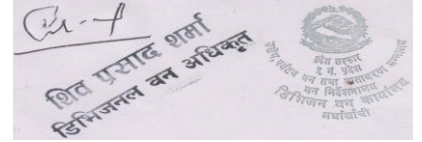

Performance Security

(On letterhead paper of the Commercial Bank or Financial Institution eligible to issue Bank Guarantee as per prevailing Law in Nepal.)

..... **Bank's Name, and Address of Issuing Branch or Office**
..... Beneficiary: Name and Address of Employer
.....
Date:

Performance Guarantee No.:

We have been informed that **[insert name of the Contractor]** (hereinafter called "the Contractor") has been notified by you to sign the Contract No. **[insert reference number of the Contract]** for the execution of **[insert name of contract and brief description of Works]** (hereinafter called "the Contract").

Furthermore, we understand that, according to the conditions of the Contract, a performance guarantee is required.

At the request of the Contractor, we... **[insert name of the Bank]** hereby irrevocably undertake to pay you any sum or sums not exceeding in total an amount of **[insert name of the currency and amount in figures*]** (... .. **insert amount in words**) such sum being payable in Nepalese Rupees, upon receipt by us of your first demand in writing accompanied by a written statement stating that the Contractor is in breach of its obligation(s) under the Contract, without your needing to prove or to show grounds for your demand or the sum specified therein.

This guarantee shall expire, no later than the.....Day of **, and any demand for payment under it must be received by us at this office on or before that date.

.....
Seal of Bank and Signature(s)

Note:
All italicized text is for guidance on how to prepare this demand guarantee and shall be deleted from the final document.
* The Guarantor shall insert an amount representing the percentage of the Contract Price specified in the Contract in Nepalese Rupees.
** Insert the date thirty days after the date specified for the Defect Liability Period. The Employer should note that in the event of an extension of the time for completion of the Contract, the Employer would need to request an extension of this guarantee from the Guarantor. Such request must be in writing and must be made prior to the expiration date established in the guarantee. In preparing this guarantee, the Employer might consider adding the following text to the form, at the end of the penultimate paragraph: "The Guarantor agrees to a one-time extension of this guarantee for a period not to exceed [six months], in response to the Employer's written request for such extension, such request to be presented to the Guarantor before the expiry of the guarantee".

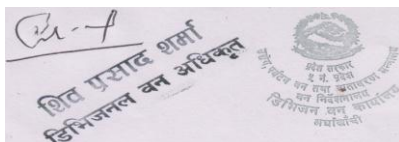

Advance Payment Security

(On **letterhead paper of the Commercial Bank or Financial Institution eligible to issue Bank Guarantee as per prevailing Law in Nepal.**)

..... **Bank's Name, and Address of Issuing Branch or Office**.....

Beneficiary: **Name and address of employer**

Date :

Advance Payment Guarantee No.....

We have been informed thathas entered into Contract No. **Name and Address of Employer**.....**name of the Contractor**.....(hereinafter called "the Contractor")..reference number of the Contract.....dated with you, for the execution of ...contract and brief description of Works (hereinafter called "the Contract").

Furthermore, we understand that, according to the Conditions of the Contract, an advance payment in the sum..... name of the currency and amount in figures*...(.... **amount in words**) is to be made against an advance payment guarantee.

At the request of the Contractor, we..... **name of the Bank** hereby irrevocably undertake to pay you any sum or sums not exceeding in total an amount of.....name of the currency and amount in figures*.....(**amount in words**) upon receipt by us of your first demand in writing accompanied by a written statement stating that the Contractor is in breach of its obligation under the Contract because the Contractor used the advance payment for purposes other than the costs of mobilization in respect of the Works.

The maximum amount of this guarantee shall be progressively reduced by the amount of the advance payment repaid by the Contractor as indicated in copies of interim statements or payment certificates which shall be presented to us. This guarantee shall expire, at the latest, upon our receipt of a copy of the interim payment certificate indicating that eighty (80) percent of the Contract Price has been certified for payment, or on the day of**, whichever is earlier. Consequently, any demand for payment under this guarantee must be received by us at this office on or before that date.

.....
Seal of Bank and Signature(s)

Note:

All italicized text is for guidance on how to prepare this demand guarantee and shall be deleted from the final document.

*The Guarantor shall insert an amount representing the amount of the advance payment in Nepalese Rupees of the advance payment as specified in the Contract.

** Insert the date Thirty days after the expected completion date. The Employer should note that in the event of an extension of the time for completion of the Contract, the Employer would need to request an extension of this guarantee from the Guarantor. Such request must be in writing and must be made prior to the expiration date established in the guarantee. In preparing this guarantee, the Employer might consider adding the following text to the form, at the end of the penultimate paragraph: "The Guarantor agrees to a one-time extension of this guarantee for a period not to exceed [six months], in response to the Employer's written request for such extension, such request to be presented to the Guarantor before the expiry of the guarantee".

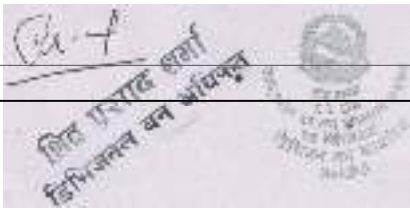

ARCHITECTURAL DRAWING OF AUDITORIUM HALL

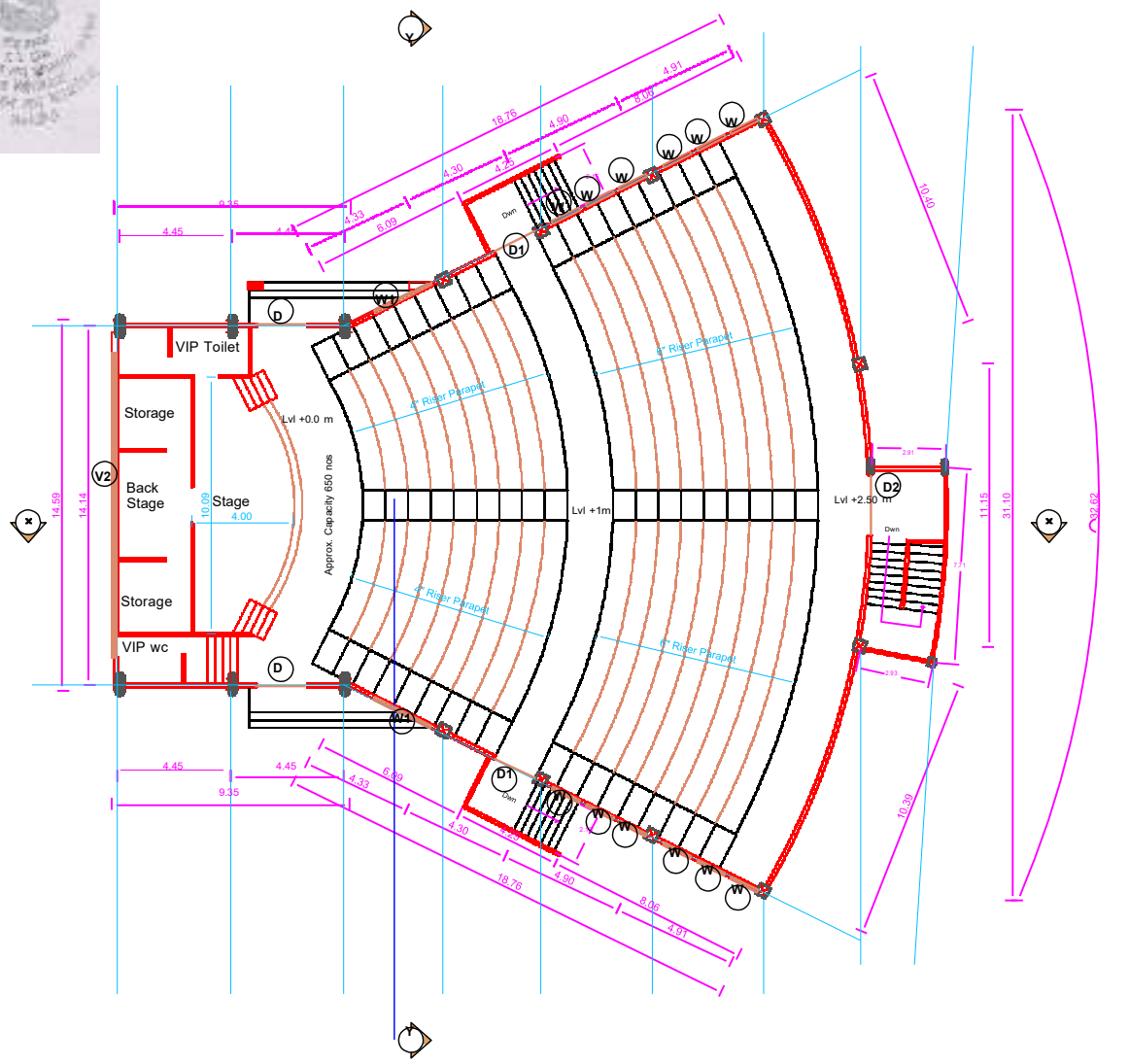
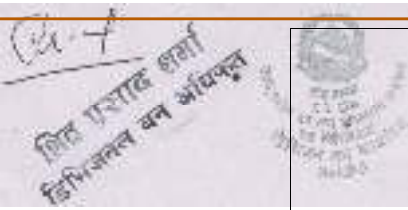

FLOOR PLAN
AREA: 600.19 SQM

CLIENT:

 PROVINCIAL GOVERNMENT
 PROVINCE NO. 5
 DIVISION FOREST OFFICE
 SANDHIKHARKA ARGHAKHACHI

PLAN | **ARCHITECTURAL DRAWINGS**

PROJECT:
 DETAIL DESIGN , COST ESTIMATE AND DRAWING OF MULTIPURPOSE AUDITORIUM HALL OF
 PANANI TAPOBHUMI ARGHAKHACHI

SCALE =
 Date : 2019

CHECKED BY:
 RECOMMENDED BY:
 APPROVED BY:

Drawing No.
AR-01

Size:
A3

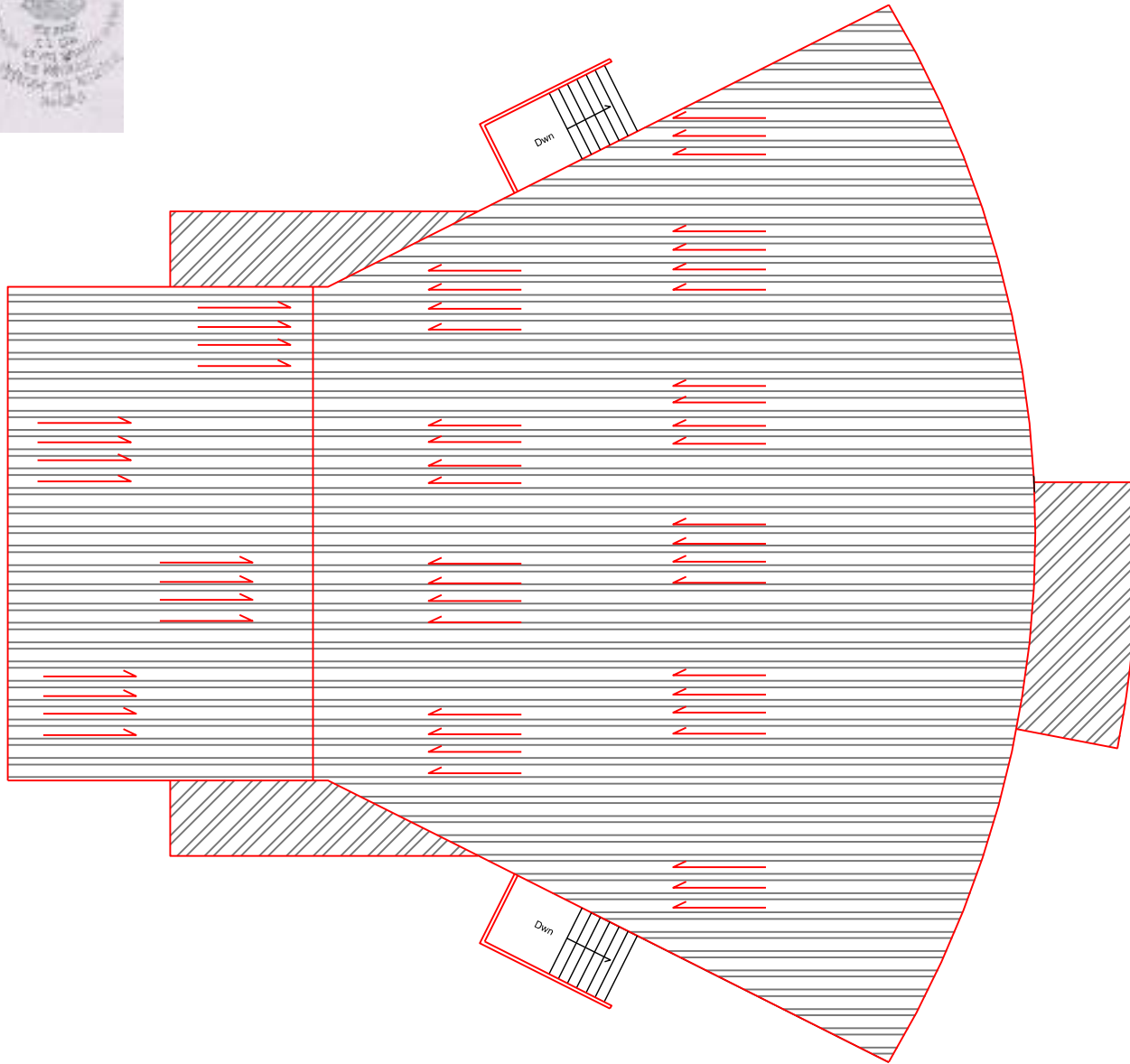
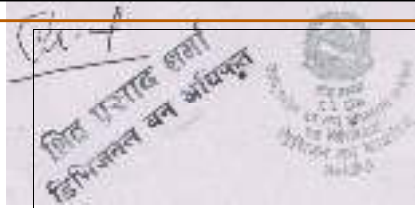

CLIENT:



PROVINCIAL GOVERNMENT
PROVINCE NO. 5
DIVISION FOREST OFFICE
SANDHIKHARKA ARGHAKHACHI

ROOF PLAN

ARCHITECTURAL DRAWINGS

PROJECT:
DETAIL DESIGN , COST ESTIMATE AND DRAWING OF MULTIPURPOSE AUDITORIUM HALL OF
PANANI TAPOBHUMI ARGHAKHACHI

SCALE =

CHECKED BY:

Date : 2019

RECOMMENDED BY:

APPROVED BY:

Drawing No.

AR-02

Size: A3

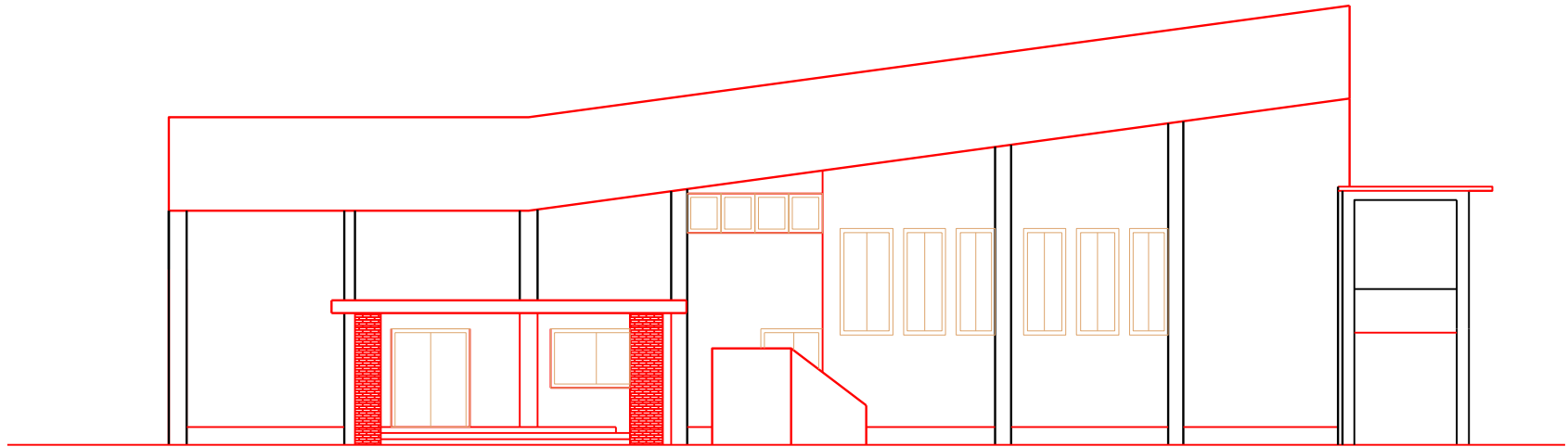
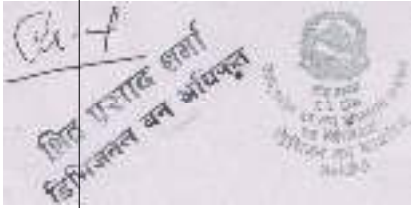

LEFT ELEVATION

CLIENT:  PROVINCIAL GOVERNMENT PROVINCE NO. 5 DIVISION FOREST OFFICE SANDHIKARKA ARGHAKHACHI	ELEVATION	ARCHITECTURAL DRAWINGS				Drawing No.
	PROJECT:		SCALE =	CHECKED BY:		AR-04
	DETAIL DESIGN , COST ESTIMATE AND DRAWING OF MULTIPURPOSE AUDITORIUM HALL OF PANANI TAPOBHUMI ARGHAKHACHI		Date : 2019	RECOMMENDED BY:	APPROVED BY:	Size: A3

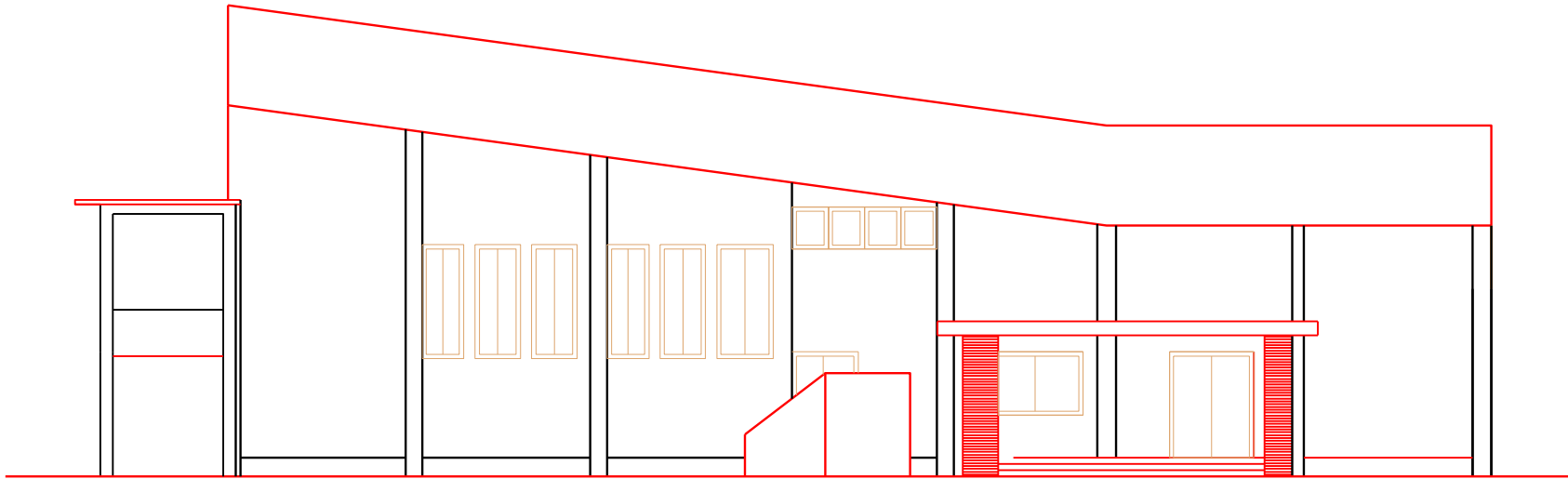
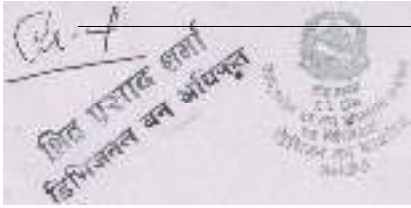

RIGHT ELEVATION

CLIENT:

PROVINCIAL GOVERNMENT
 PROVINCE NO. 5
 DIVISION FOREST OFFICE
 SANDHIKHARKA ARGHAKHACHI

ELEVATION

ARCHITECTURAL DRAWINGS

PROJECT:
 DETAIL DESIGN , COST ESTIMATE AND DRAWING OF MULTIPURPOSE AUDITORIUM HALL OF
 PANANI TAPOBHUMI ARGHAKHACHI

SCALE =

CHECKED BY:

Date - 2019

RECOMMENDED BY:

APPROVED BY:

Drawing No.

AR-05

Size:

A3

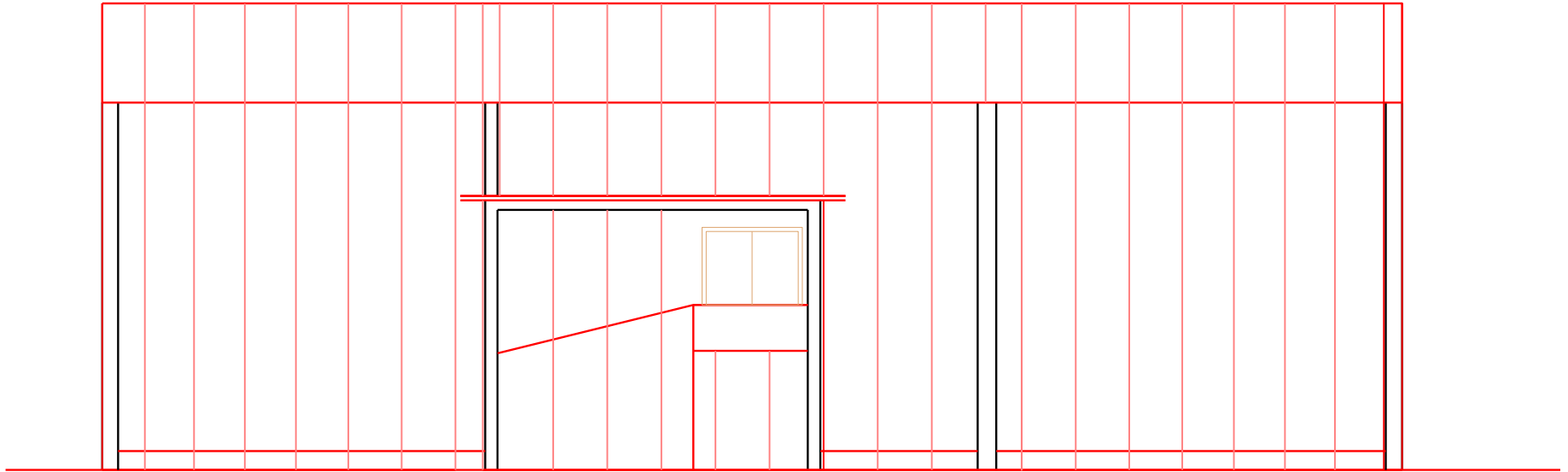
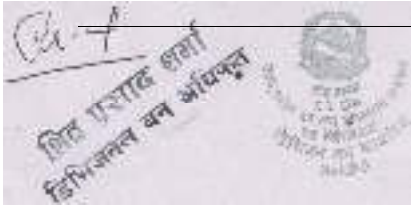

FRONT ELEVATION

CLIENT:

PROVINCIAL GOVERNMENT
PROVINCE NO. 5
DIVISION FOREST OFFICE
SANDHIKHARKA ARGHAKHACHI

ELEVATION

ARCHITECTURAL DRAWINGS

Drawing No.

PROJECT:
DETAIL DESIGN , COST ESTIMATE AND DRAWING OF MULTIPURPOSE AUDITORIUM HALL OF
PANANI TAPOBHUMI ARGHAKHACHI

SCALE =

CHECKED BY:

AR-03

Date - 2019

RECOMMENDED BY:

APPROVED BY:

Size:

A3

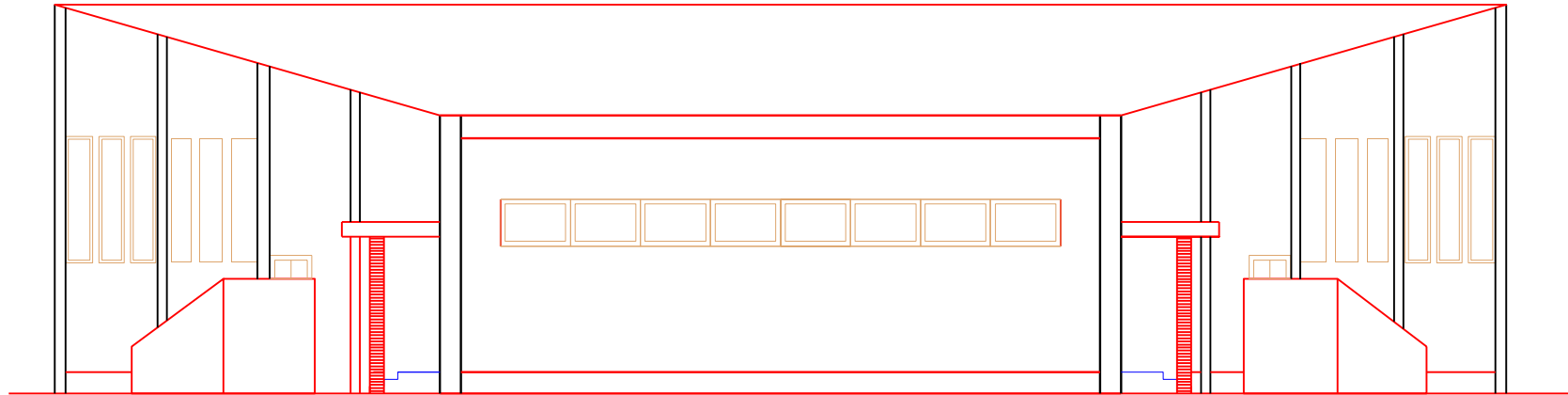
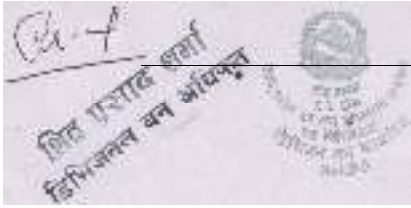

BACK ELEVATION

CLIENT:



PROVINCIAL GOVERNMENT
PROVINCE NO. 5
DIVISION FOREST OFFICE
SANDHIKARKA ARGHAKHACHI

ELEVATION

ARCHITECTURAL DRAWINGS

Drawing No.

PROJECT:

**DETAIL DESIGN , COST ESTIMATE AND DRAWING OF MULTIPURPOSE AUDITORIUM HALL OF
PANANI TAPOBHUMI ARGHAKHACHI**

SCALE =

CHECKED BY:

AR-06

Date : 2019

RECOMMENDED BY:

APPROVED BY:

Size:

A2

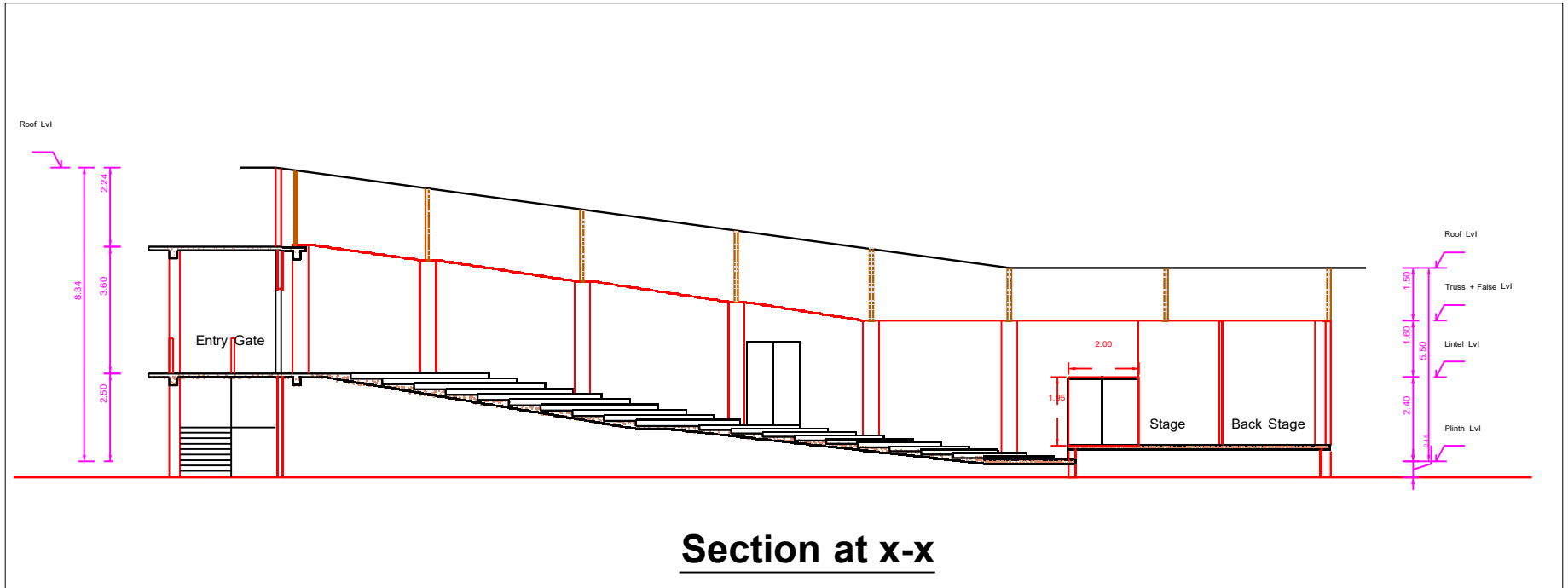
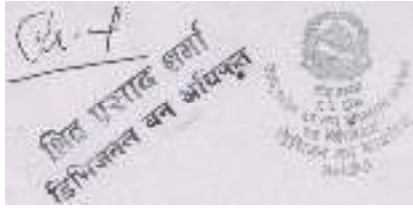

CLIENT:  PROVINCIAL GOVERNMENT PROVINCE NO. 5 DIVISION FOREST OFFICE SANDHIKHARKA ARGHAKHACHI	SECTION	ARCHITECTURAL DRAWINGS				Drawing No.
	PROJECT: DETAIL DESIGN , COST ESTIMATE AND DRAWING OF MULTIPURPOSE AUDITORIUM HALL OF PANANI TAPOBHUMI ARGHAKHACHI		SCALE =	CHECKED BY:		AR-07
			Date : 2019	RECOMMENDED BY:	APPROVED BY:	Size:

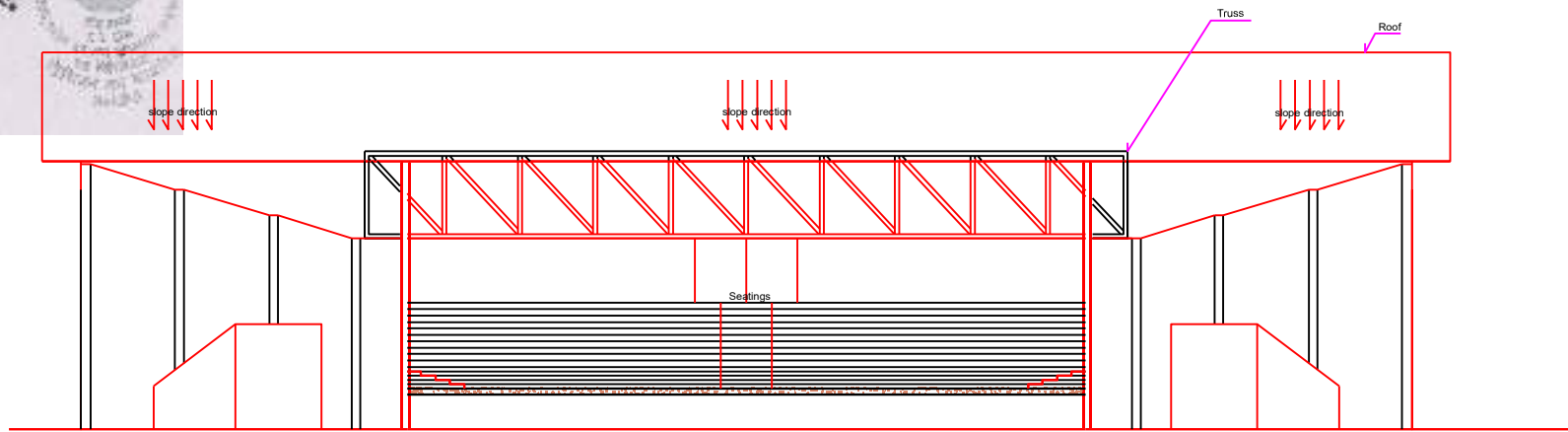
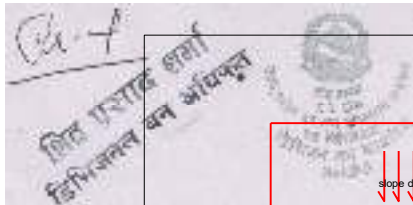

Section at Y-Y

DOORS & WINDOWS SCHEDULE:

S.N.	SYMBOL	SIZES	N.O.S.
1.	W	1.2 x 2.7	12
2.	W1	2.5 X 1.5	2
3.	V	4.0 x 1.0	2
4.	V2	12.0 X 1.0	1
5.	D	2.0 X 2.5	2
6.	D1	1.8 X 2.4	2
7.	D2	2.4 X 2.4	1
8.	D3	1.0 x 2.1	3
9.	D4	0.75 X 2.1	2
TOTAL			27

CLIENT:



PROVINCIAL GOVERNMENT
PROVINCE NO. 5
DIVISION FOREST OFFICE
SANDHIKHARKA ARGGHAKACHI

SECTION

ARCHITECTURAL DRAWINGS

PROJECT:
DETAIL DESIGN , COST ESTIMATE AND DRAWING OF MULTIPURPOSE AUDITORIM HALL OF
PANANI TAPOBHUMI ARGGHAKACHI

SCALE =

Date : 2019

CHECKED BY:

RECOMMENDED BY:

APPROVED BY:

Drawing No.

AR-08

Size:

A3

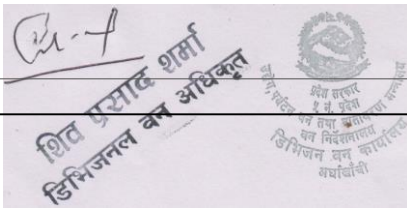

STRUCTURAL DRAWING OF AUDOTORIUM HALL

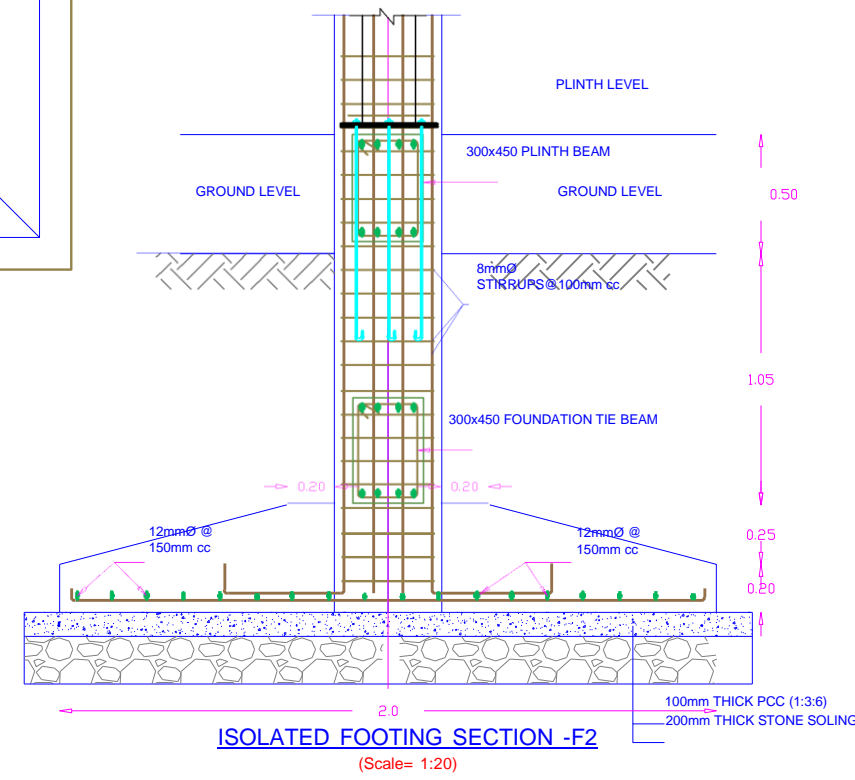
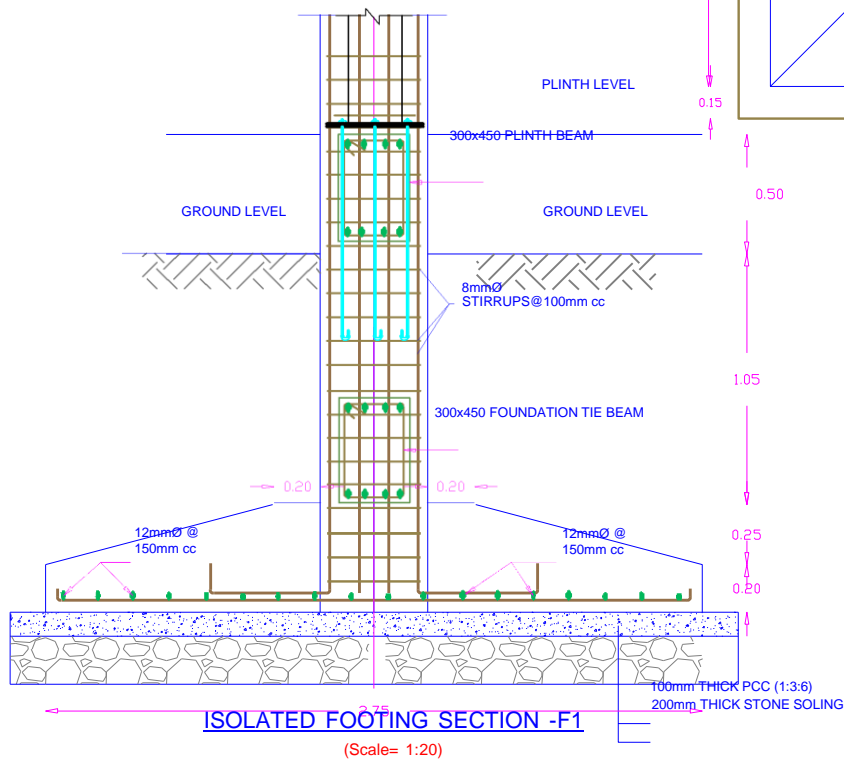
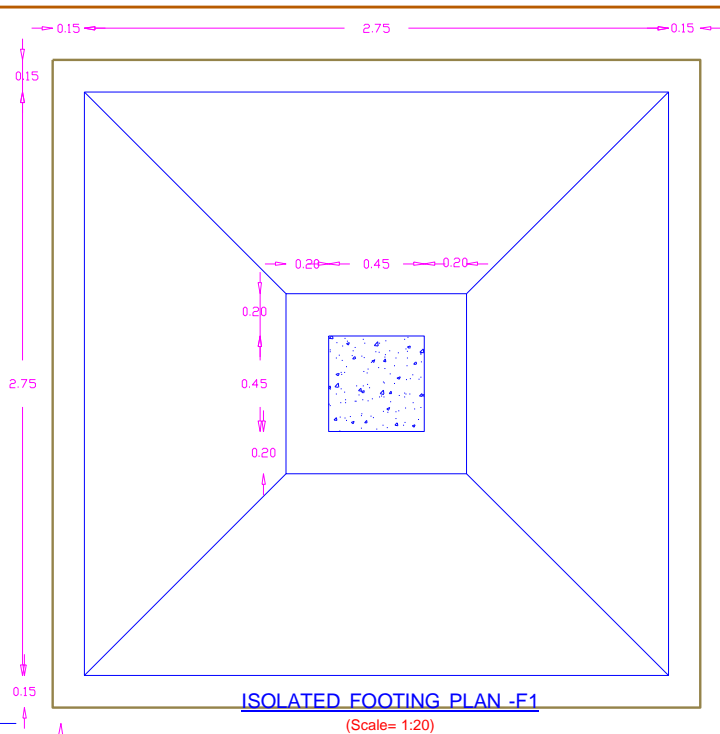
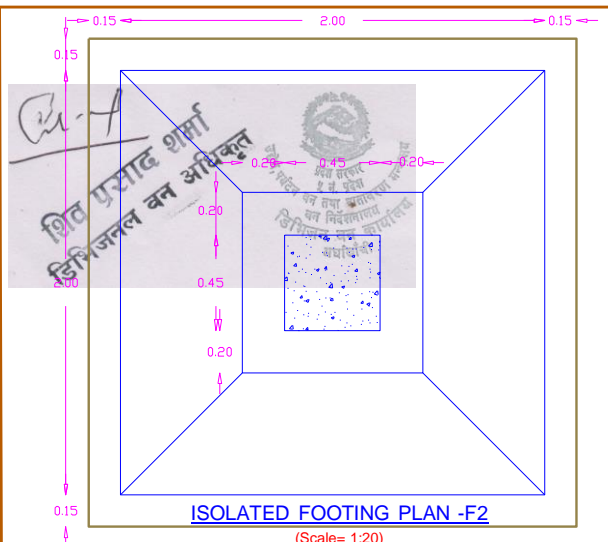

CLIENT:
 GOVERNMENT OF PROVINCE
 PROVINCE NO. 5
 MINISTRY OF INDUSTRY, TOURISM, FOREST & ENVIRONMENT
 FOREST DIRECTORATE
 DIVISION FOREST OFFICE, ARGHAKHANCHI

STRUCTURAL DRAWINGS
PROJECT:
 DETAILED DESIGN , COST ESTIMATE AND DRAWING OF MULTIPURPOSE AUDITORIUM HALL
 OF PANANI TAPOBHUMI, ARGHAKACHI

SCALE =		CHECKED BY		Drawing No	
Date 2019		RECOMMENDED BY		ST-02	
		APPROVED BY		Size A3	

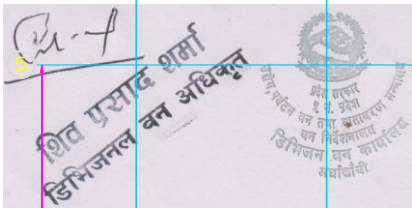
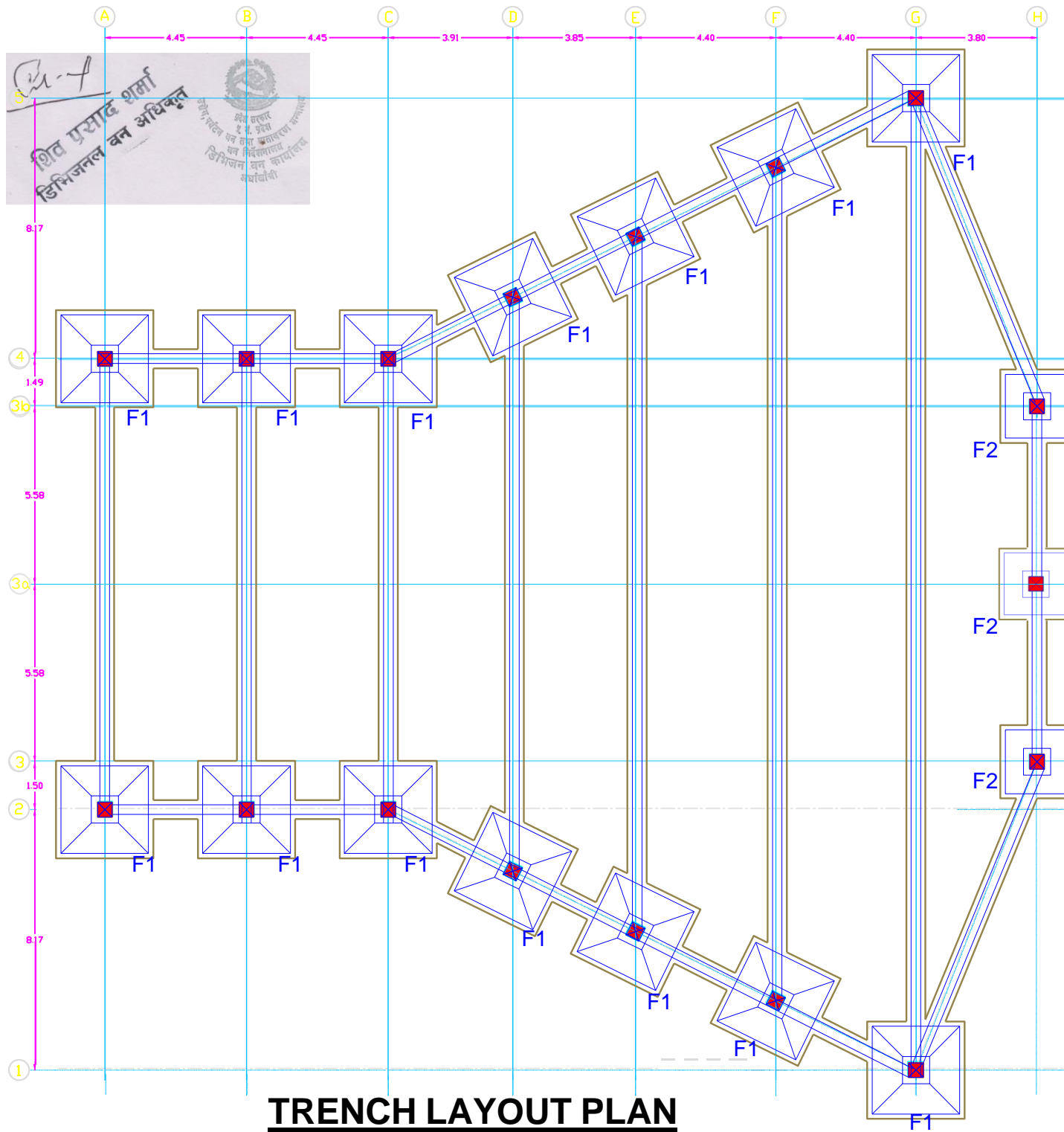

TRENCH LAYOUT PLAN

शिव प्रसाद शर्मा
 डिभिजनल वन अधिकृत
 डी. वन. प्र. प्र. ५
 डी. वन. प्र. प्र. ५
 डी. वन. प्र. प्र. ५
 डी. वन. प्र. प्र. ५

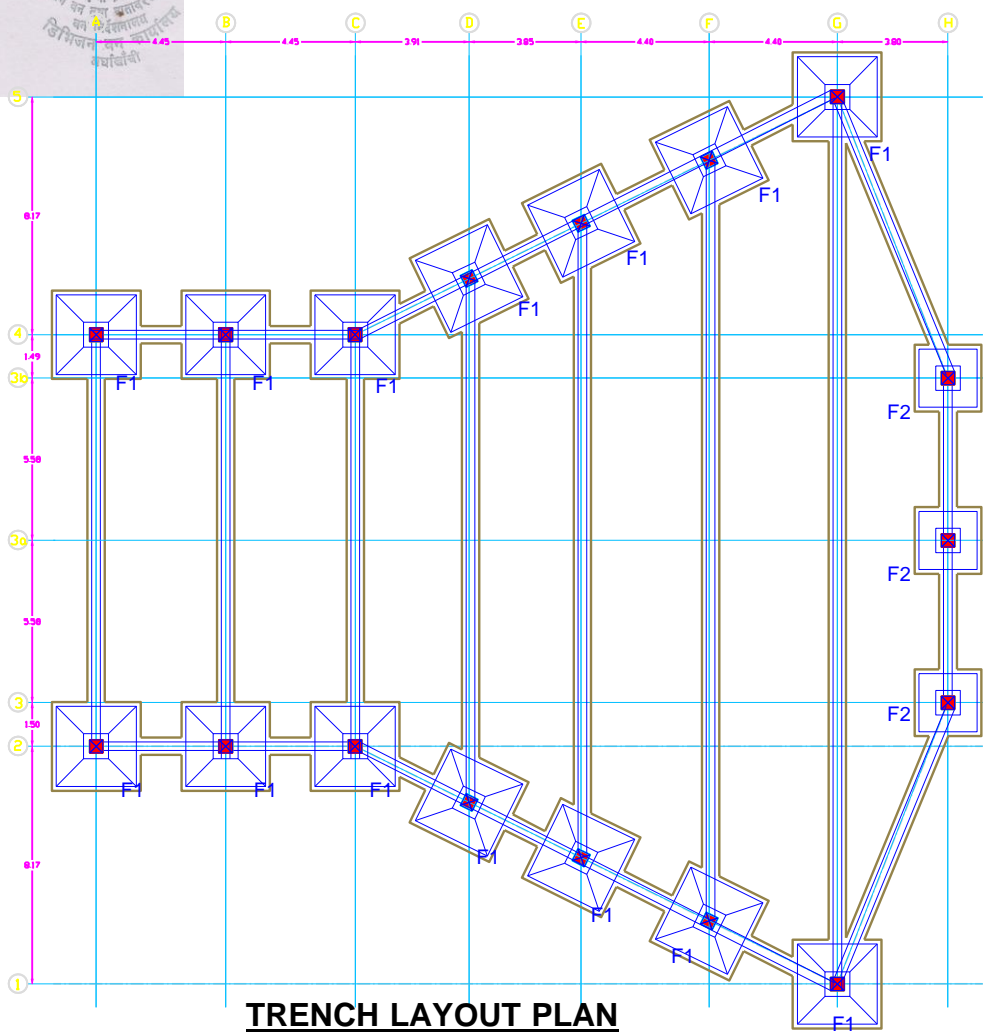

TRENCH LAYOUT PLAN

CLIENT: GOVERNMENT OF PROVINCE PROVINCE NO. 5  MINISTRY OF INDUSTRY, TOURISM, FOREST & ENVIRONMENT FOREST DIRECTORATE DIVISION FOREST OFFICE, ARGHAKHANCHI	STRUCTURAL DRAWINGS			Drawing No ST-01 Size A3
	PROJECT: DETAILED DESIGN, COST ESTIMATE AND DRAWING OF MULTIPURPOSE AUDITORIUM HALL OF PANANI TAPOBHUMI, ARGHAKACHI			
			CHECKED BY: RECOMMENDED BY: APPROVED BY:	

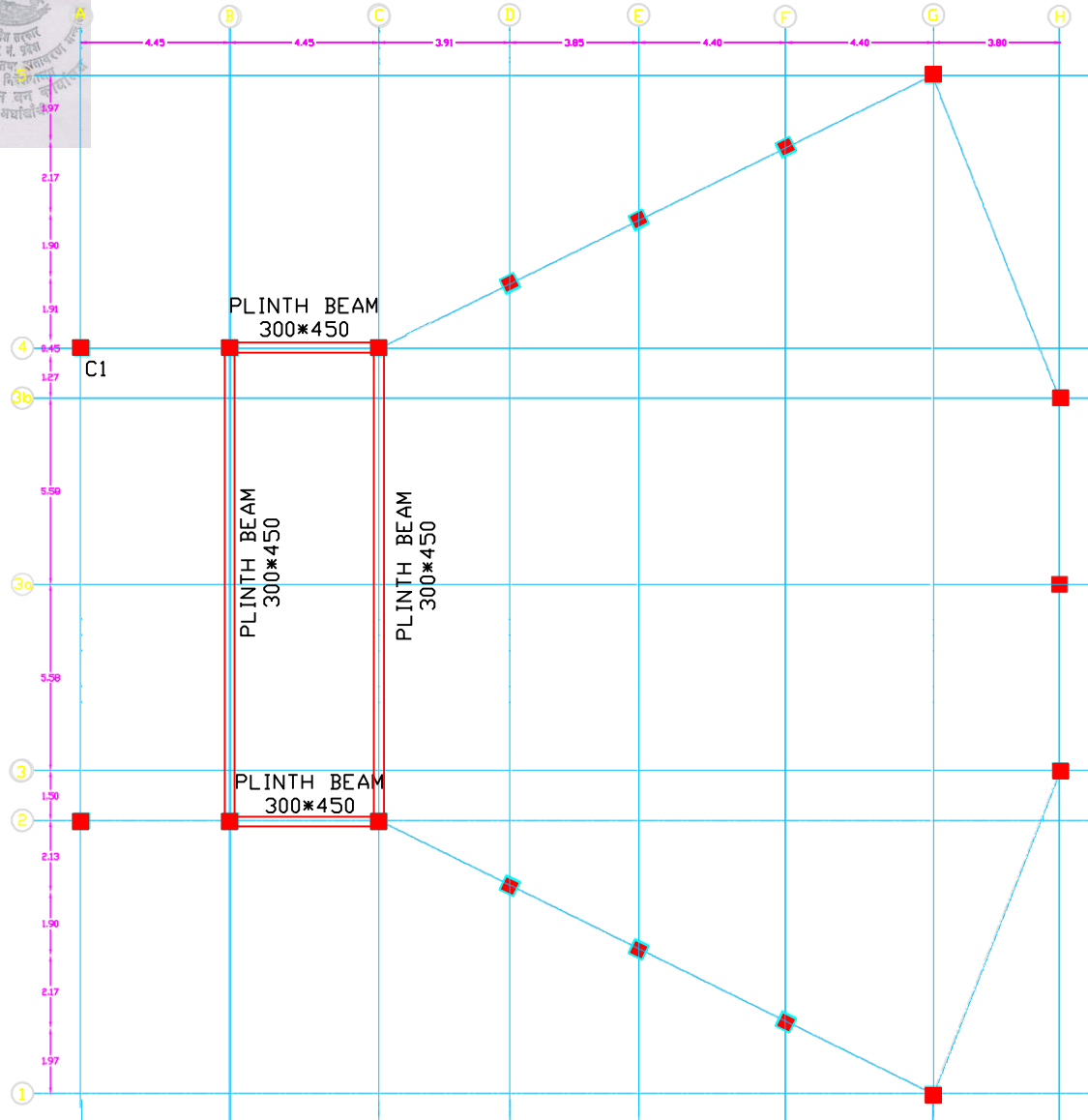
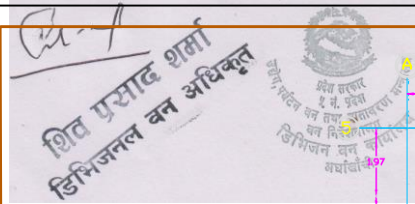

**PLINTH BEAM LAYOUT PLAN
AT+0.5M LEVEL**

CLIENT:  GOVERNMENT OF PROVINCE PROVINCE NO. 5 MINISTRY OF INDUSTRY, TOURISM, FOREST & ENVIRONMENT FOREST DIRECTORATE DIVISION FOREST OFFICE, ARGHAKHANCHI	STRUCTURAL DRAWINGS			Drawing No		
	PROJECT: DETAILED DESIGN, COST ESTIMATE AND DRAWING OF MULTIPURPOSE AUDITORIUM HALL OF PANANI TAPOBHUMI, ARGHAKHANCHI			SCALE	CHECKED BY	ST-04
	D L 2019	PREPARED BY	APPROVED BY	Size	A3	

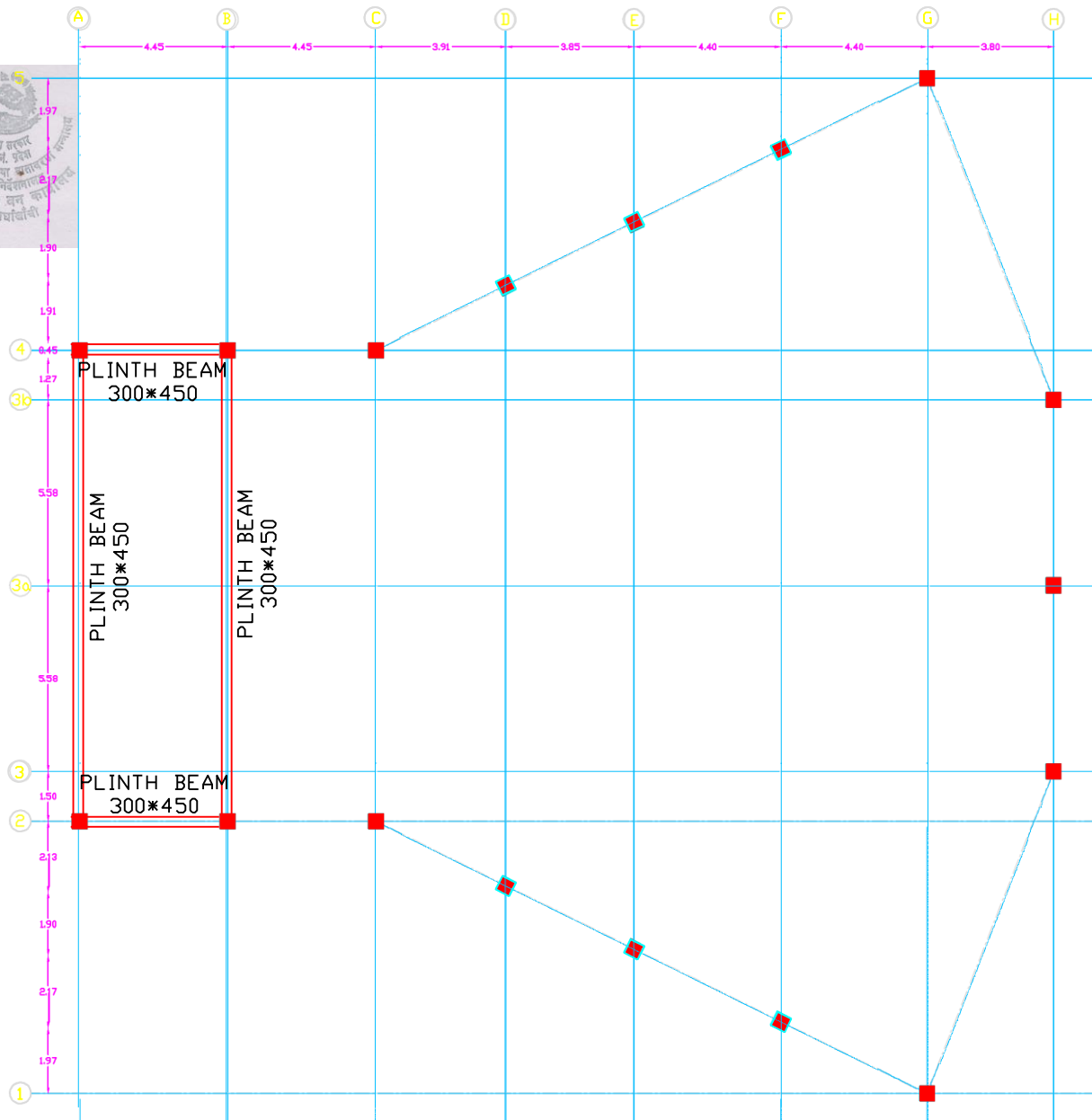
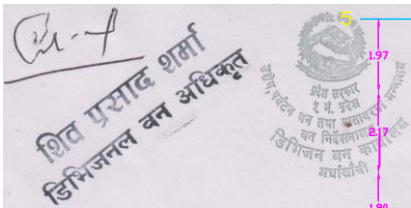

**PLINTH BEAM LAYOUT PLAN
AT+1M LEVEL**

CLIENT:
GOVERNMENT OF PROVINCE
PROVINCE NO. 5

MINISTRY OF INDUSTRY, TOURISM, FOREST & ENVIRONMENT
FOREST DIRECTORATE
DIVISION FOREST OFFICE, ARGHAKHANCHI

STRUCTURAL DRAWINGS

PROJECT:
DETAILED DESIGN , COST ESTIMATE AND DRAWING OF MULTIPURPOSE AUDITORIM HALL
OF PANANI TAPOBHUMI, ARGHAKACHI

			Drawing No.
SCALE =	CHECKED BY:		ST-05
Date : 2019	RECOMMENDED BY:	APPROVED BY:	Size: A3

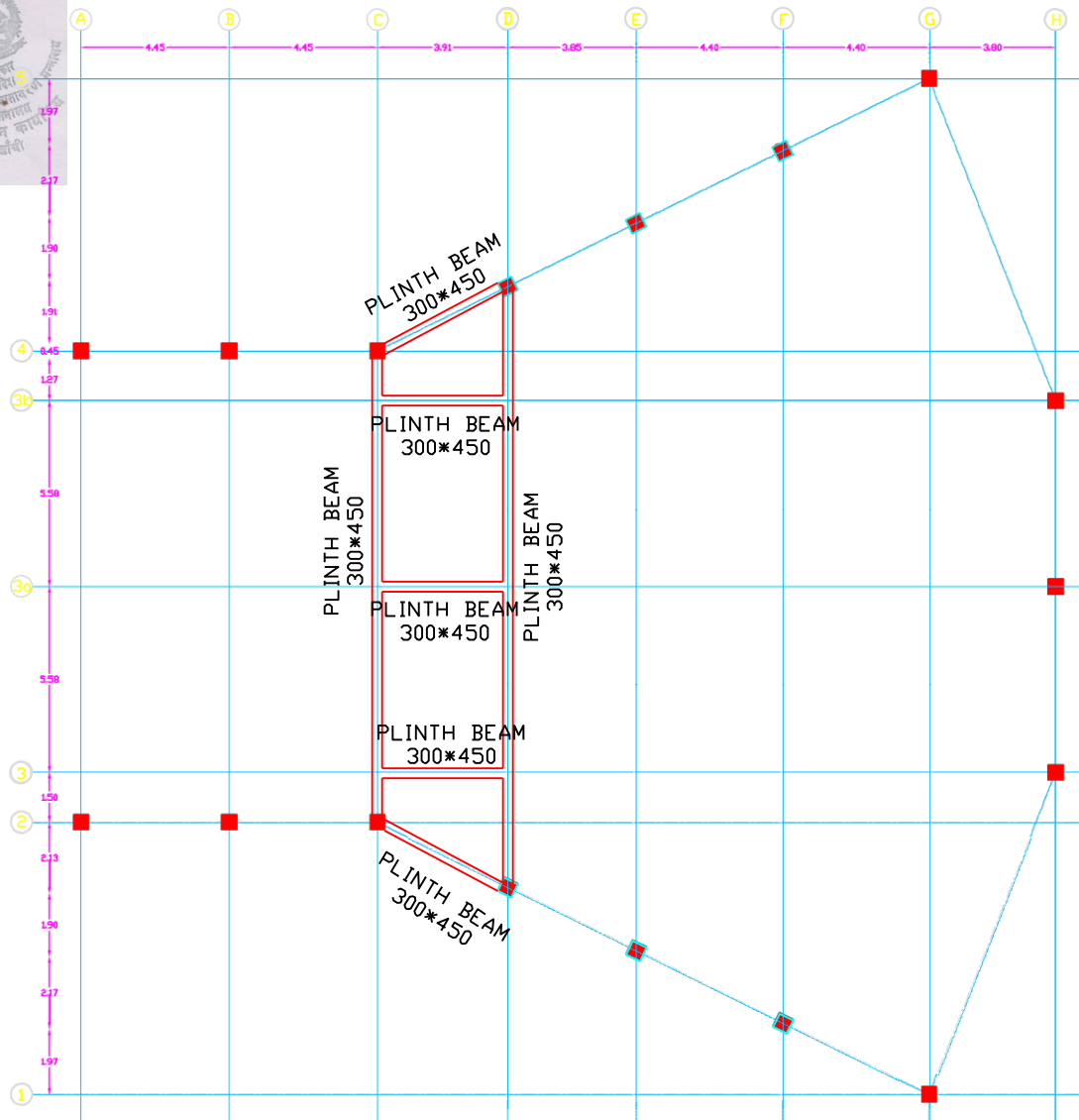
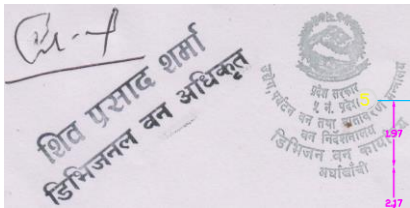

**PLINTH BEAM LAYOUT PLAN
AT+1.1M LEVEL**

CLIENT:

 GOVERNMENT OF PROVINCE
 PROVINCE NO. 5
 MINISTRY OF INDUSTRY, TOURISM, FOREST & ENVIRONMENT
 FOREST DIRECTORATE
 DIVISION FOREST OFFICE, ARGHAKHANCHI

STRUCTURAL DRAWINGS

PROJECT:
 DETAILED DESIGN , COST ESTIMATE AND DRAWING OF MULTIPURPOSE AUDITORIUM HALL
 OF PANANI TAPOBHUMI, ARGHAKHANCHI

SCALE	CHITRA 11		Drawing No
D L 2019	PGCMMFGND 11	APPPMVG D 11	ST-06
			Size A3

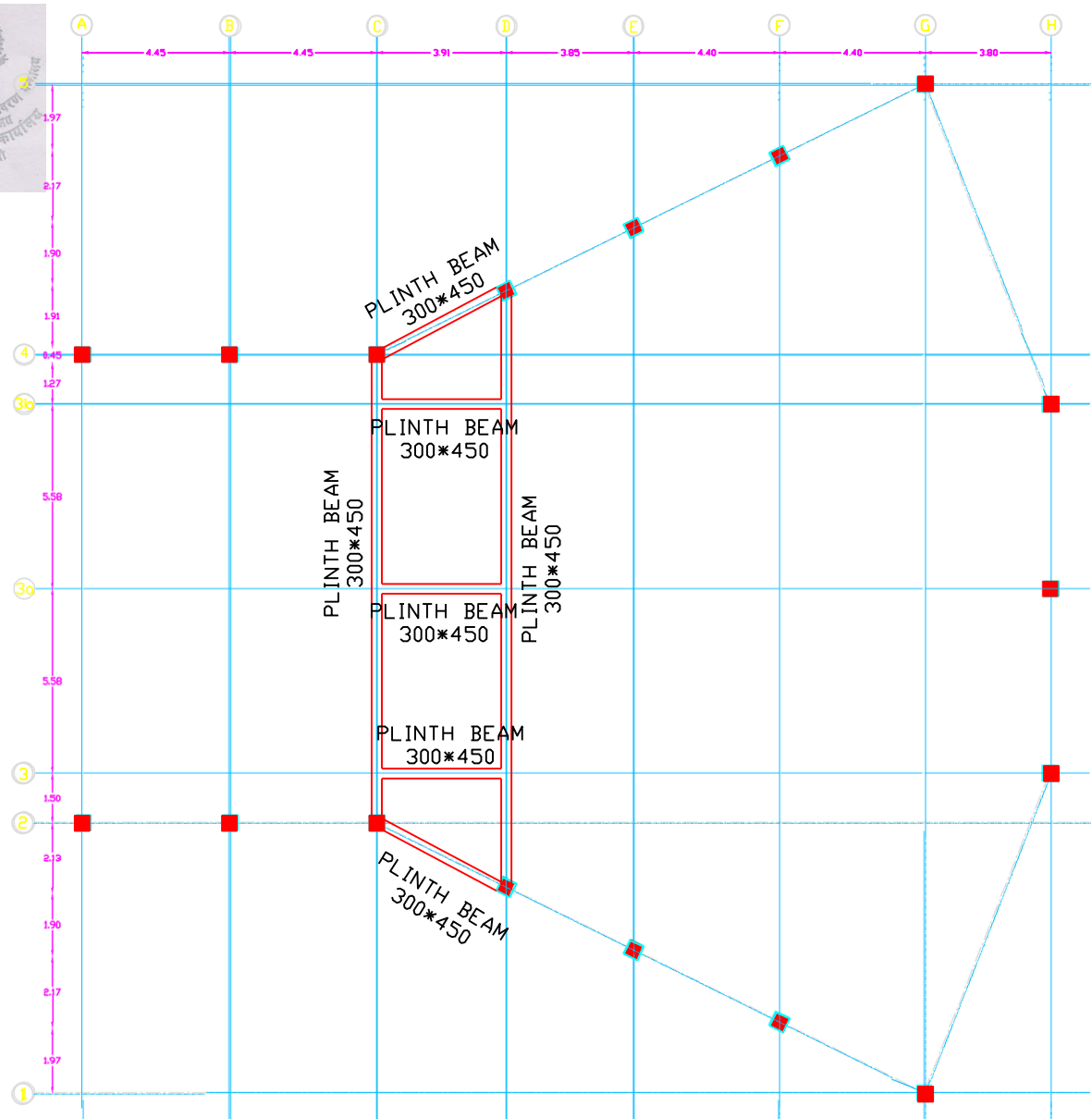
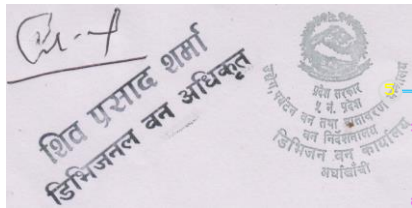
Drawing No
ST-06
 Size **A3**



**PLINTH BEAM LAYOUT PLAN
AT+1.1M LEVEL**

CLIENT:  GOVERNMENT OF PROVINCE PROVINCE NO. 5 MINISTRY OF INDUSTRY, TOURISM, FOREST & ENVIRONMENT FOREST DIRECTORATE DIVISION FOREST OFFICE, ARGHAKHANCHI	STRUCTURAL DRAWINGS			Drawing No		
	PROJECT: DETAILED DESIGN , COST ESTIMATE AND DRAWING OF MULTIPURPOSE AUDITORIUM HALL OF PANANI TAPOBHUMI, ARGHAKACHI			SCALE	CHECKED BY	ST-06
	D L 2019	PFC	APPP	Size	A3	

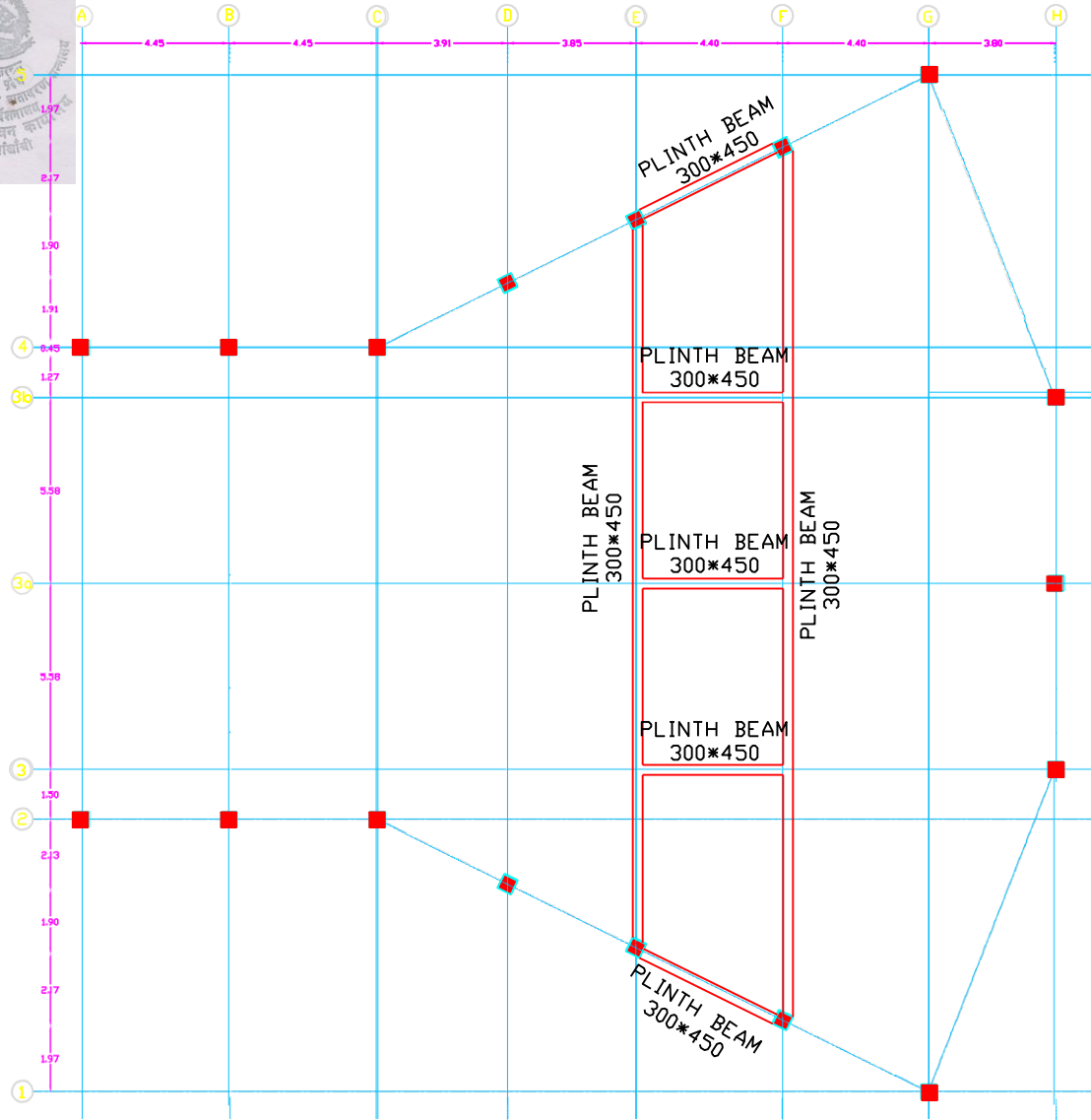
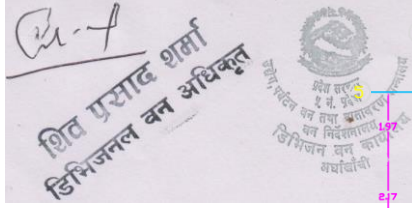

**PLINTH BEAM LAYOUT PLAN
AT+2.4 LEVEL**

CLIENT:

 GOVERNMENT OF PROVINCE
 PROVINCE NO. 5
 MINISTRY OF INDUSTRY, TOURISM, FOREST & ENVIRONMENT
 FOREST DIRECTORATE
 DIVISION FOREST OFFICE, ARGHAKHANCHI

STRUCTURAL DRAWINGS

PROJECT:
 DETAILED DESIGN , COST ESTIMATE AND DRAWING OF MULTIPURPOSE AUDITORIM HALL
 OF PANANI TAPOBHUMI, ARGHAKACHI

SCALE	CHIEF D 11		Drawng No
D L 2019	PFCMMFNDG 11	APPPVVGD 11	ST-08
			Size A3

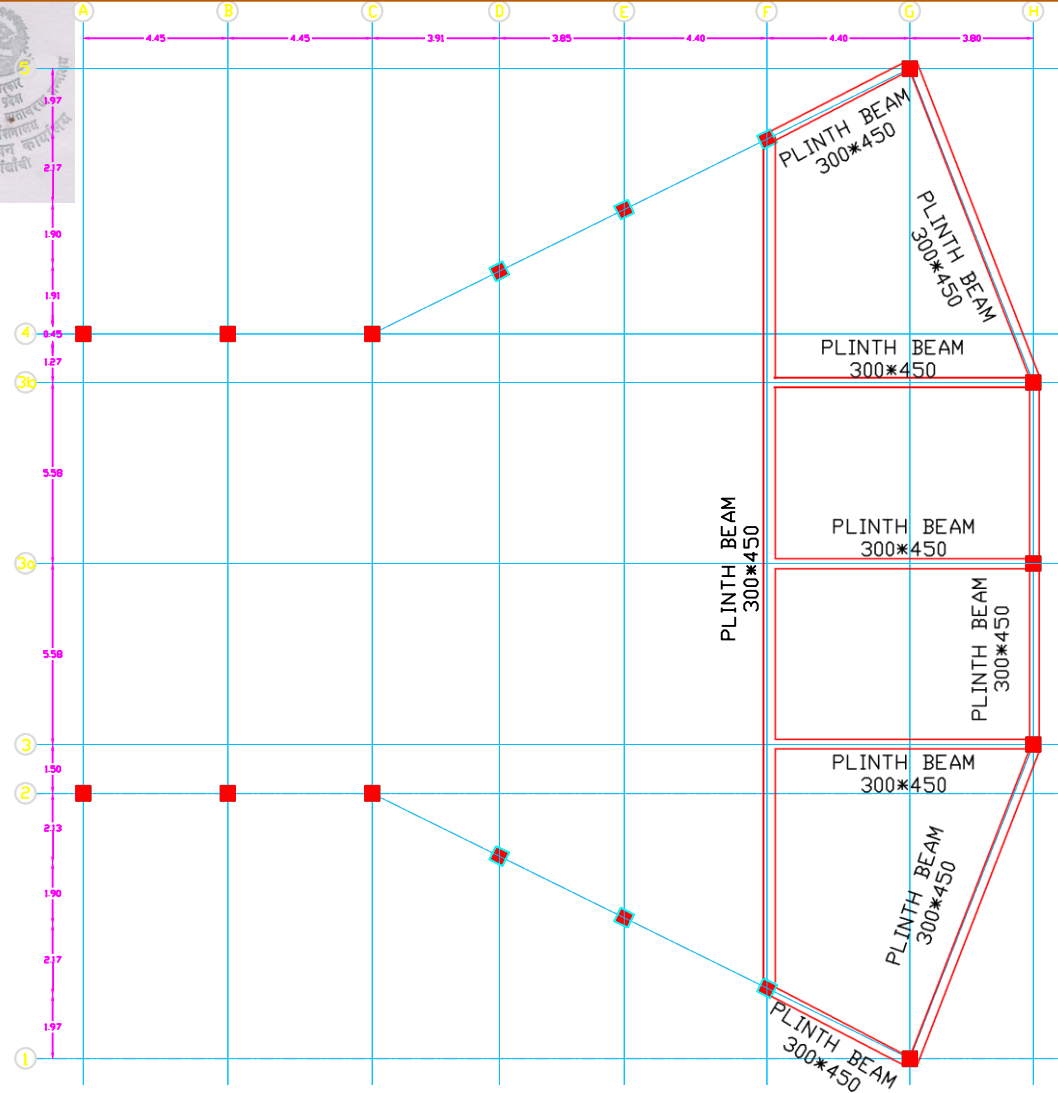
शिव प्रसाद शर्मा
 डिभिजनल वन अधिकृत
 प्रेम कल्ले
 इ. में. प्रस्ता
 वन निदेशनालय
 डिभिजनल वन कार्यालय
 अर्घाखाँची



**PLINTH BEAM LAYOUT PLAN
 AT+3.1 LEVEL**

CLIENT: GOVERNMENT OF PROVINCE PROVINCE NO. 5 MINISTRY OF INDUSTRY, TOURISM, FOREST & ENVIRONMENT FOREST DIRECTORATE DIVISION FOREST OFFICE, ARGHAKHANCHI	STRUCTURAL DRAWINGS	SUBMITTED BY INTERFACE ENGINEERING PVT. LTD		Drawing No
	PROJECT: DETAILED DESIGN , COST ESTIMATE AND DRAWING OF MULTIPURPOSE AUDITORIUM HALL OF PANANI TAPOBHUMI, ARGHAKACHI	SCALE	CHECKED BY	ST-09
		DATE 2019	PREPARED BY	SIZE A3

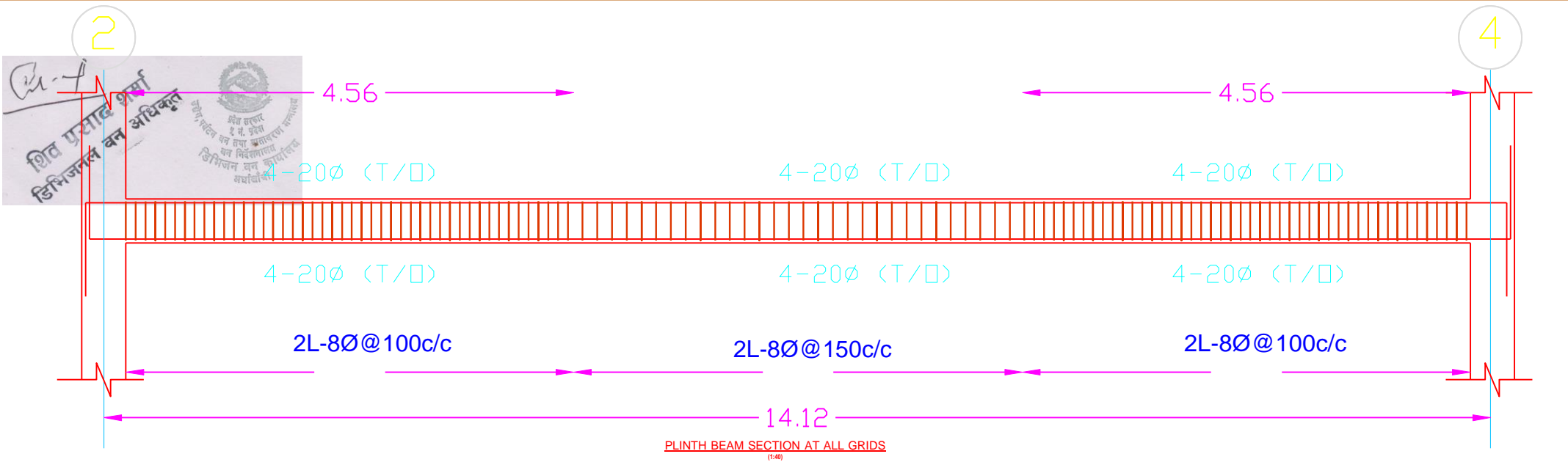

PLINTH BEAM SECTION AT ALL GRIDS
(1-40)

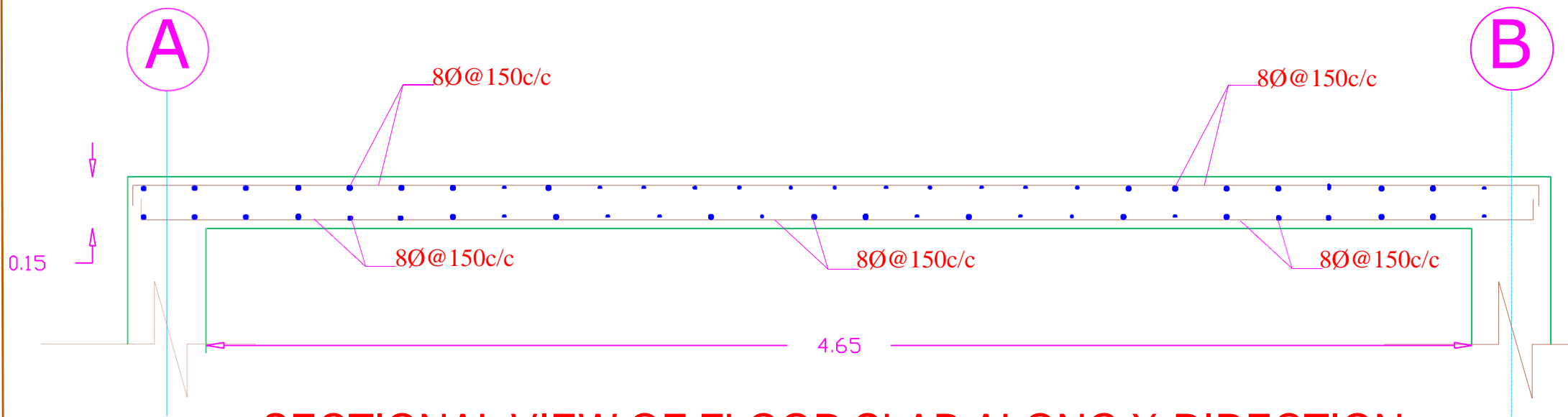

SECTIONAL VIEW OF FLOOR SLAB ALONG X-DIRECTION

CLIENT:
 GOVERNMENT OF PROVINCE
 PROVINCE NO. 5
 MINISTRY OF INDUSTRY, TOURISM, FOREST & ENVIRONMENT
 FOREST DIRECTORATE
 DIVISION FOREST OFFICE, ARGHAKHANCHI

STRUCTURAL DRAWINGS

PROJECT:
 DETAILED DESIGN , COST ESTIMATE AND DRAWING OF MULTIPURPOSE AUDITORIM HALL
 OF PANANI TAPOBHUMI, ARGHAKACHI

Drawing No.		
SCALE =	CHECKED BY:	ST-10
Date : 2019	RECOMMENDED BY:	APPROVED BY:
		Size: A3

शिव प्रसाद शर्मा
 डिभिजनल वन अधिकृत
 डिभिजन वन कार्यालय
 अर्घाखाँची

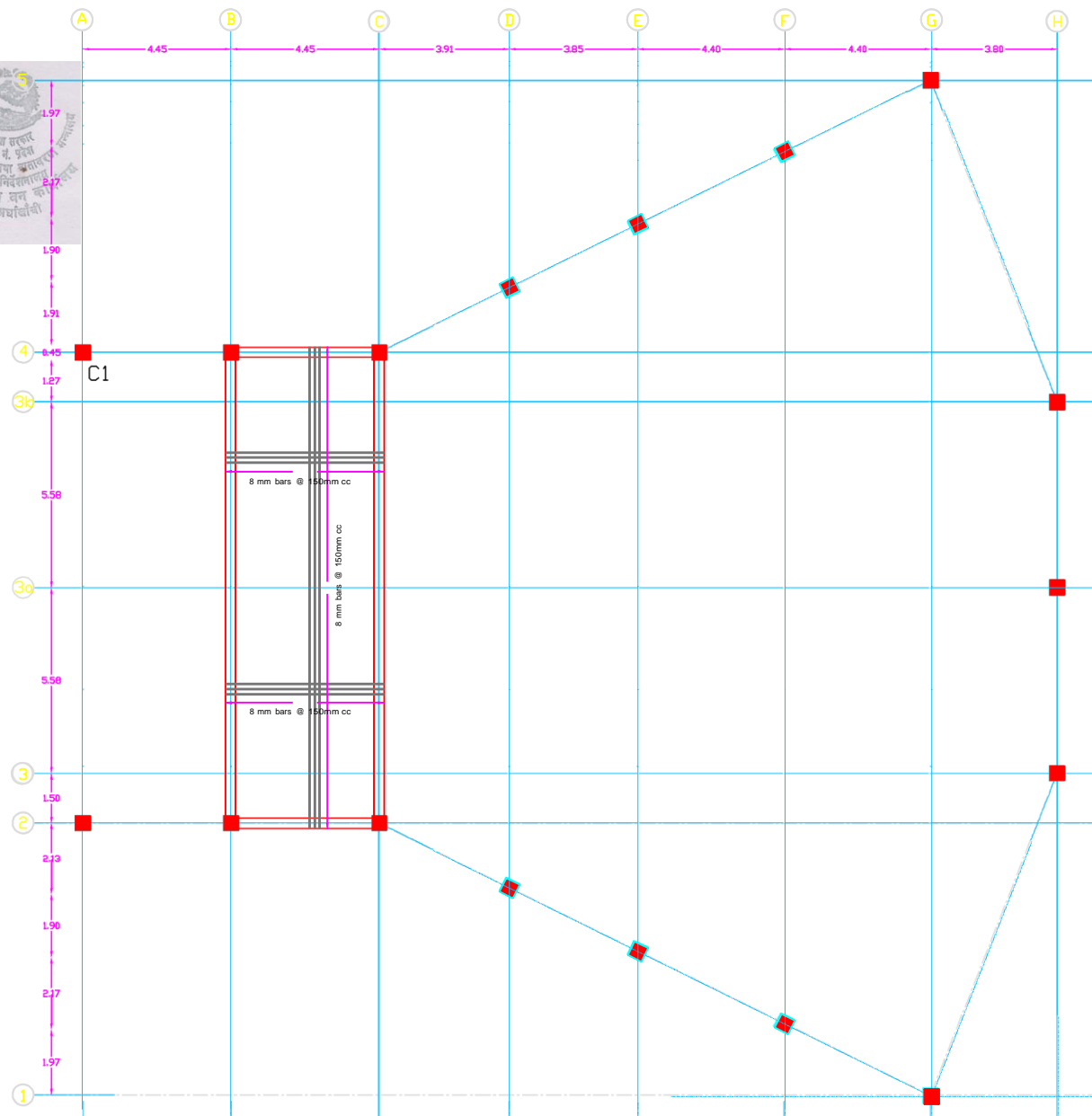

**TOP AND BOTTOM REINFORCEMENT OF
 SLAB
 AT+0.5M LEVEL**

CLIENT:
 GOVERNMENT OF PROVINCE
 PROVINCE NO. 5
 MINISTRY OF INDUSTRY, TOURISM, FOREST & ENVIRONMENT
 FOREST DIRECTORATE
 DIVISION FOREST OFFICE, ARGHAKHANCI

PROJECT:
 DETAILED DESIGN, COST ESTIMATE AND DRAWING OF MULTIPURPOSE AUDITORIUM HALL
 OF PANANI TAPOBHUMI, ARGHAKACHI

Drawing No		ST-11	
Date	2019	Prepared By	APP
Size		A3	

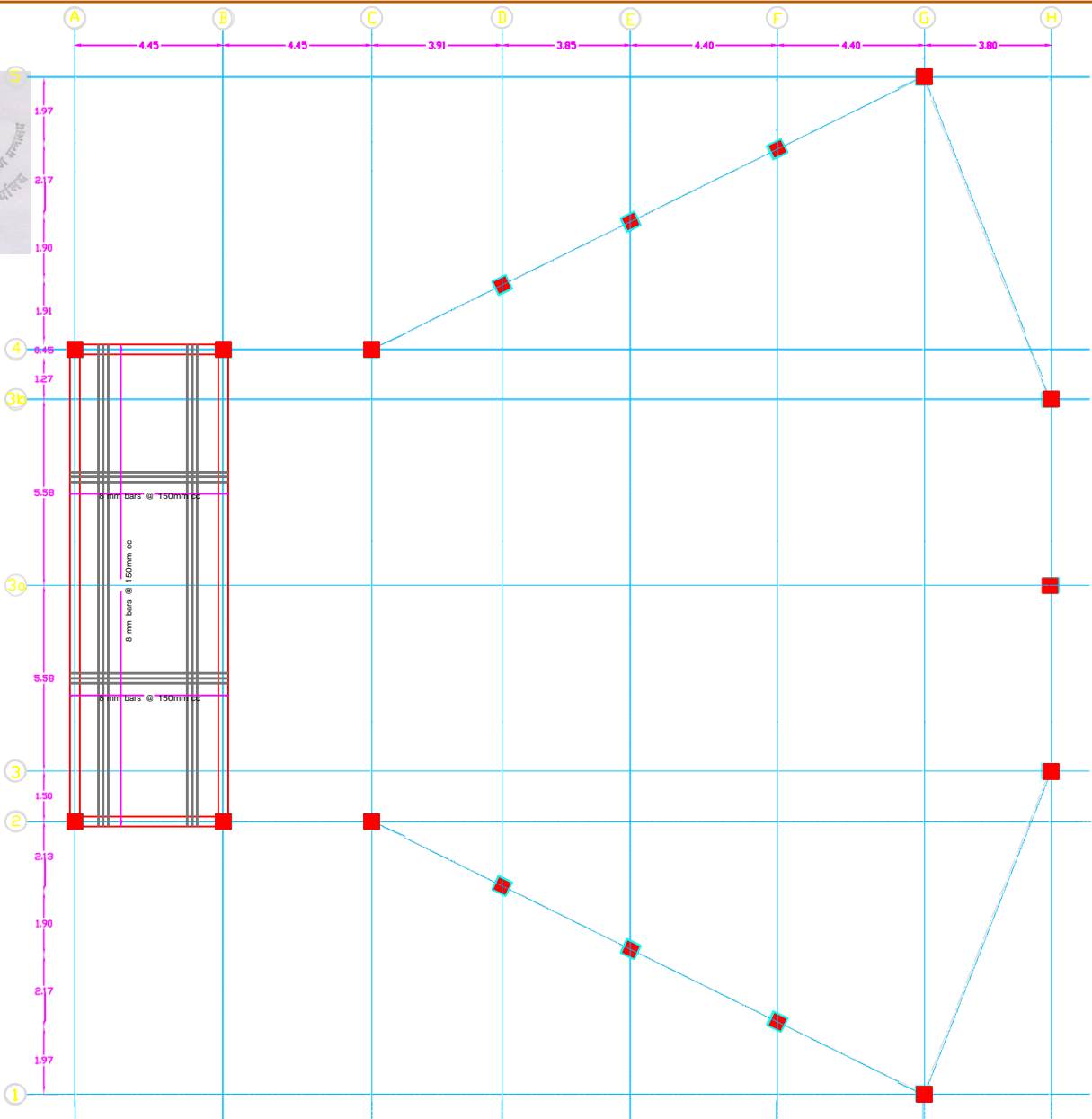
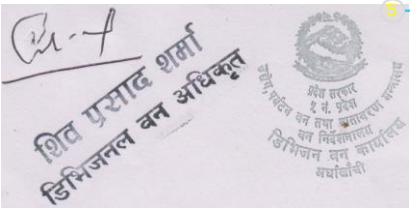

TOP AND BOTTOM REINFORCEMENT OF SLAB AT+1M LEVEL

CLIENT: GOVERNMENT OF PROVINCE PROVINCE NO. 5 MINISTRY OF INDUSTRY, TOURISM, FOREST & ENVIRONMENT FOREST DIRECTORATE DIVISION FOREST OFFICE, ARGHAKHANCHI	STRUCTURAL DRAWINGS			Drawing No	
	PROJECT: DETAILED DESIGN, COST ESTIMATE AND DRAWING OF MULTIPURPOSE AUDITORIUM HALL OF PANANI TAPOBHUMI, ARGHAKACHI	SCALE	CHANGED BY	DATE	ST-12
		Date: 2019	PROJECT MANAGER	APPROVED BY	Size: A3

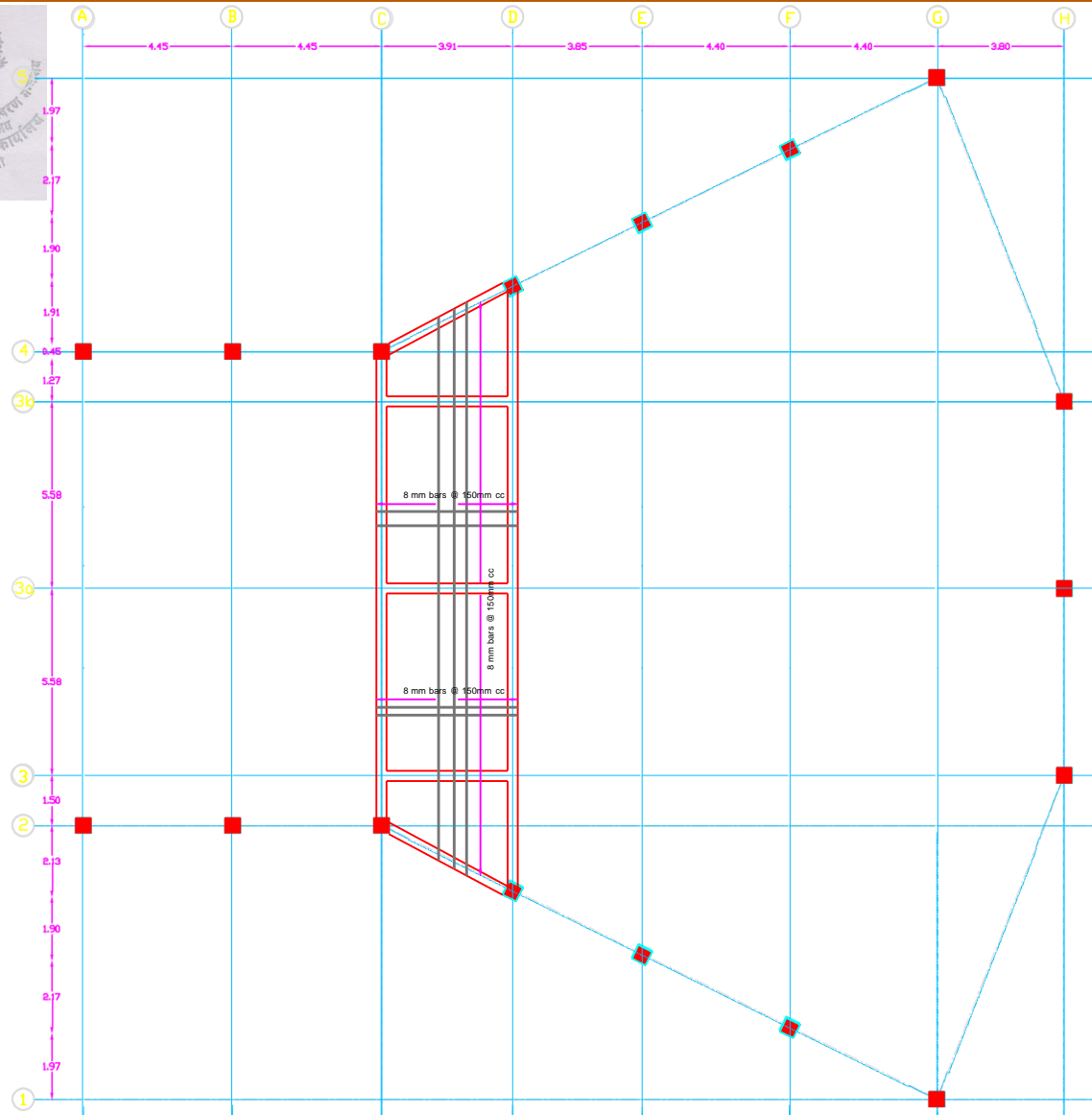

**TOP AND BOTTOM REINFORCEMENT OF
SLAB
AT+1.1M LEVEL**

CLIENT:
 GOVERNMENT OF PROVINCE
 PROVINCE NO. 5
 MINISTRY OF INDUSTRY, TOURISM, FOREST & ENVIRONMENT
 FOREST DIRECTORATE
 DIVISION FOREST OFFICE, ARGHAKHANCHI

STRUCTURAL DRAWINGS

PROJECT:
 DETAILED DESIGN, COST ESTIMATE AND DRAWING OF MULTIPURPOSE AUDITORIUM HALL
 OF PANANI TAPOBHUMI, ARGHAKHANCHI

SCALE = CHFCI FD 1\)
 D t 2019 PCCMMFNDGD B\ APPPVCD 1\)

Drawing No
ST-13
 Size **A3**

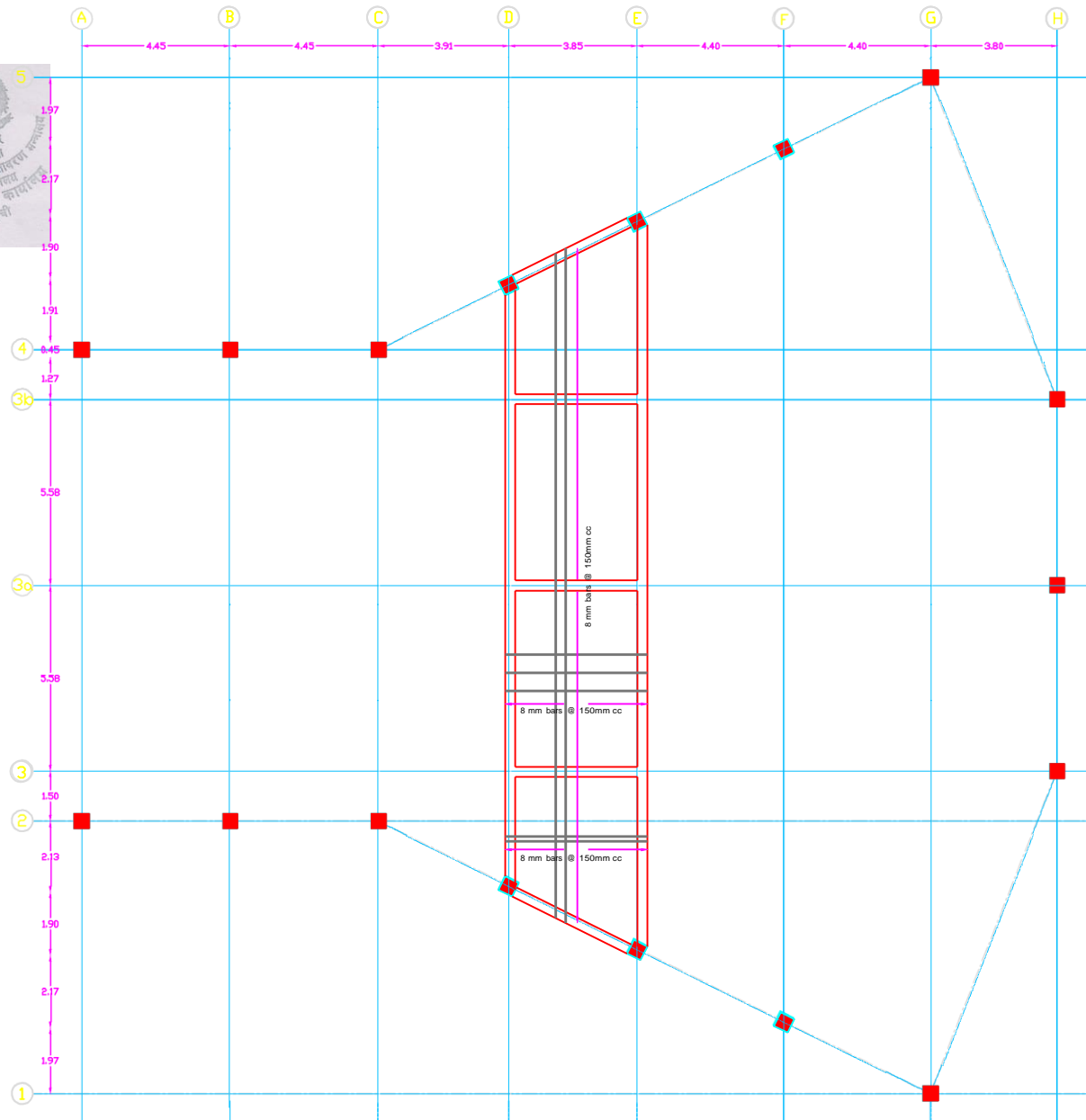

**TOP AND BOTTOM REINFORCEMENT OF
SLAB
AT+1.8M LEVEL**

CLIENT:  GOVERNMENT OF PROVINCE PROVINCE NO. 5 MINISTRY OF INDUSTRY, TOURISM, FOREST & ENVIRONMENT FOREST DIRECTORATE DIVISION FOREST OFFICE, ARGHAKHANCHI	STRUCTURAL DRAWINGS			Drawing No		
	PROJECT: DETAILED DESIGN , COST ESTIMATE AND DRAWING OF MULTIPURPOSE AUDITORIUM HALL OF PANANI TAPOBHUMI, ARGHAKACHI			SCALE	CHIEF D R	ST-14
	Date 2019	PFC	APPR	VTD	Size	A3

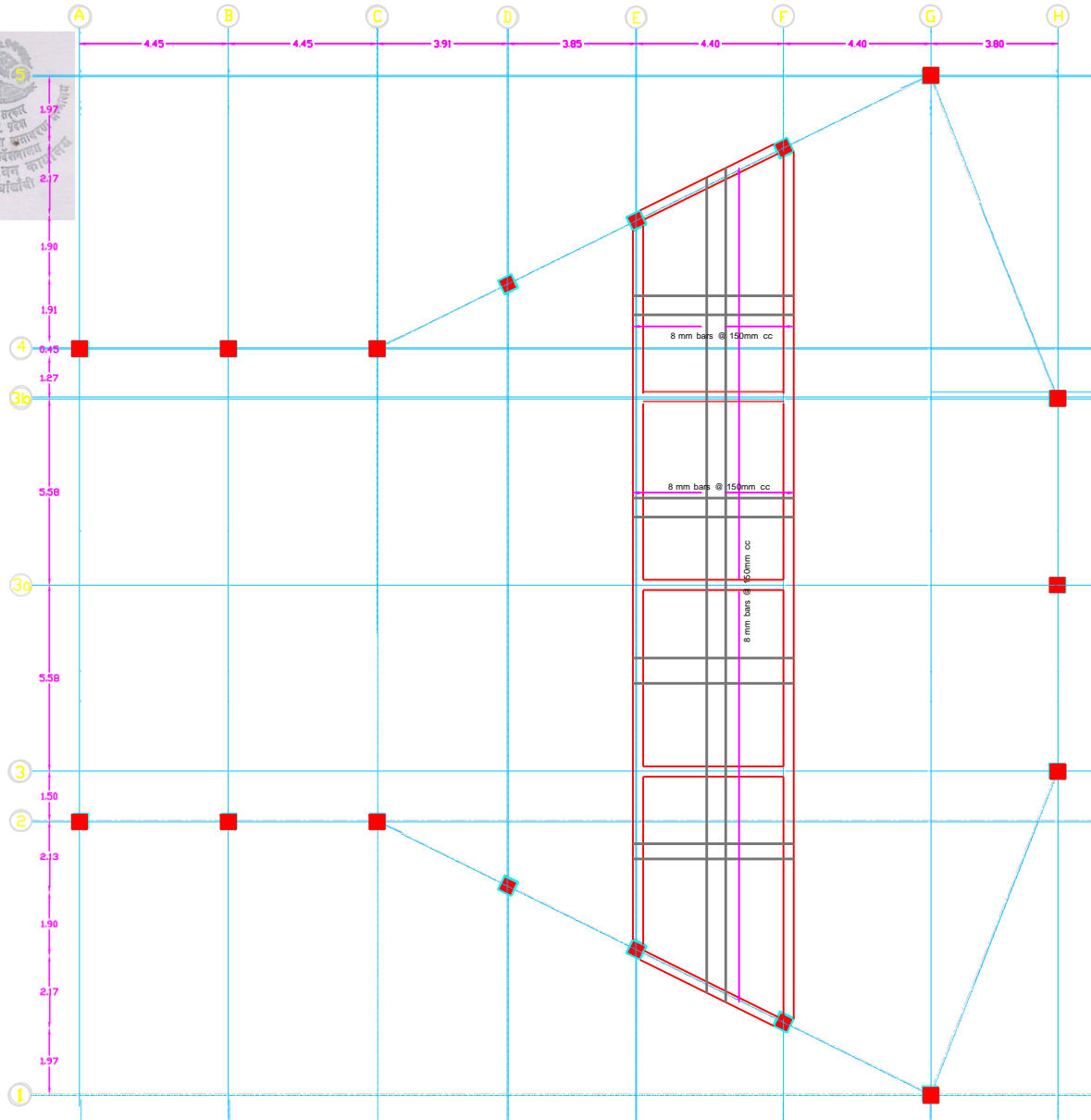

**TOP AND BOTTOM REINFORCEMENT OF
SLAB
AT+2.4M LEVEL**

CLIENT:
 GOVERNMENT OF PROVINCE
 PROVINCE NO. 5
 MINISTRY OF INDUSTRY, TOURISM, FOREST & ENVIRONMENT
 FOREST DIRECTORATE
 DIVISION FOREST OFFICE, ARGHAKHANCHI

STRUCTURAL DRAWINGS

PROJECT:
 DETAILED DESIGN , COST ESTIMATE AND DRAWING OF MULTIPURPOSE AUDITORIUM HALL
 OF PANANI TAPOBHUMI, ARGHAKACHI

SCALE =
 DATE: 2019
 CHECKED BY:
 APPROVED BY:

Drawing No
ST-15
 Size **A3**

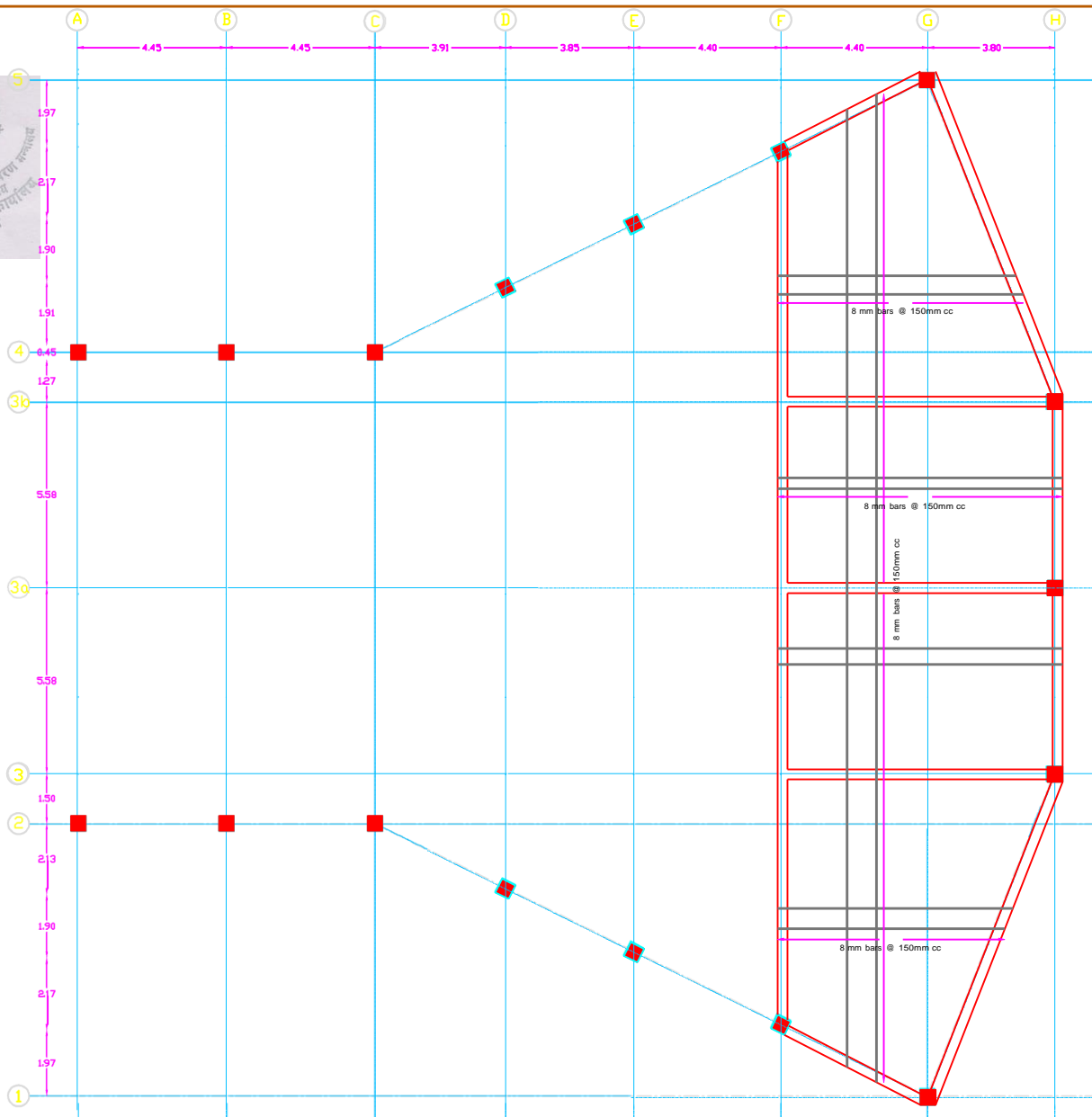

**TOP AND BOTTOM REINFORCEMENT OF
SLAB
AT+3.1M LEVEL**

CLIENT: GOVERNMENT OF PROVINCE PROVINCE NO. 5  MINISTRY OF INDUSTRY, TOURISM, FOREST & ENVIRONMENT FOREST DIRECTORATE DIVISION FOREST OFFICE, ARGHAKHANCHI	STRUCTURAL DRAWINGS				Drawing No
	PROJECT: DETAILED DESIGN, COST ESTIMATE AND DRAWING OF MULTIPURPOSE AUDITORIUM HALL OF PANANI TAPOBHUMI, ARGHAKACHI	SCALE =	CHECKED BY		ST-16
		Date 2019	RECOMMENDED BY	APPROVED BY	Size A3

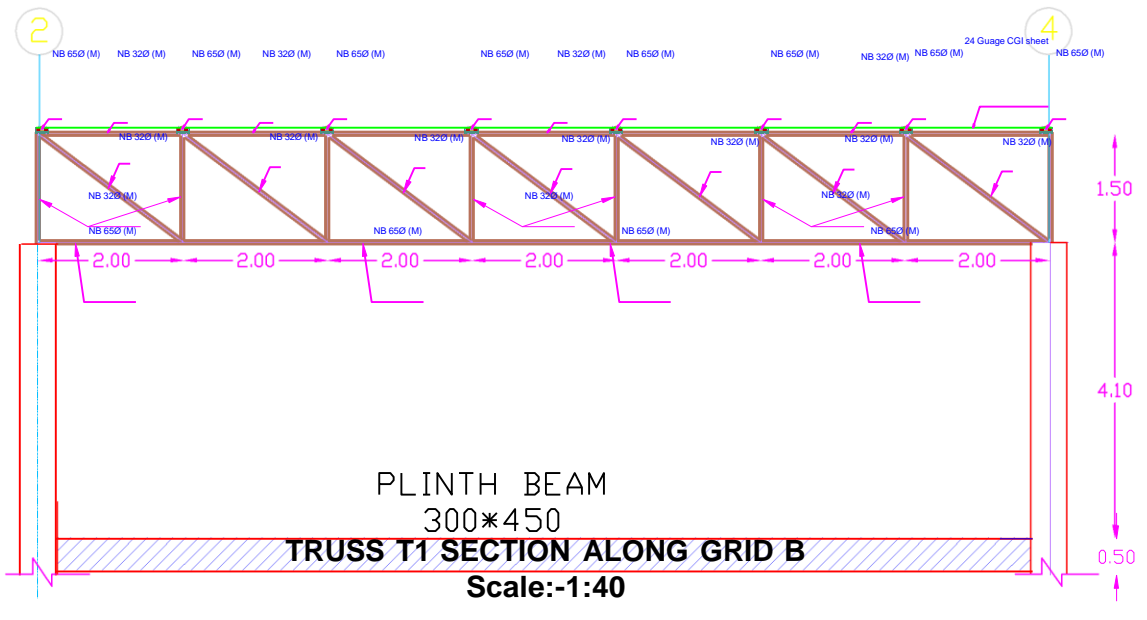
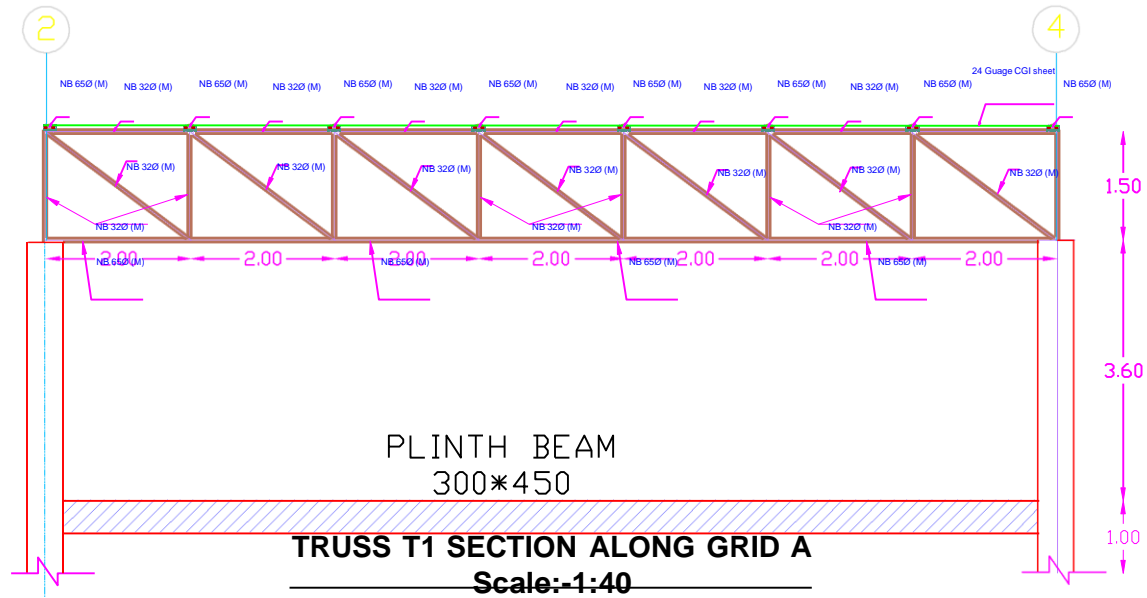
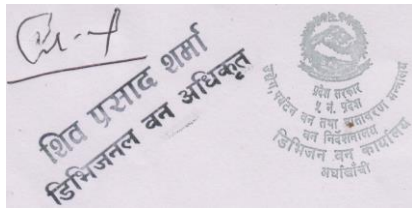

CLIENT: GOVERNMENT OF PROVINCE PROVINCE NO. 5 MINISTRY OF INDUSTRY, TOURISM, FOREST & ENVIRONMENT FOREST DIRECTORATE DIVISION FOREST OFFICE, ARGHAKHANCHI	STRUCTURAL DRAWINGS		Drawing No	
	PROJECT: DETAILED DESIGN , COST ESTIMATE AND DRAWING OF MULTIPURPOSE AUDITORIM HALL OF PANANI TAPOBHUMI, ARGHAKACHI		SCALE =	CHECKED BY
	Date 2019	RECOMMENDED BY	APPROVED BY	ST-17 Size A3

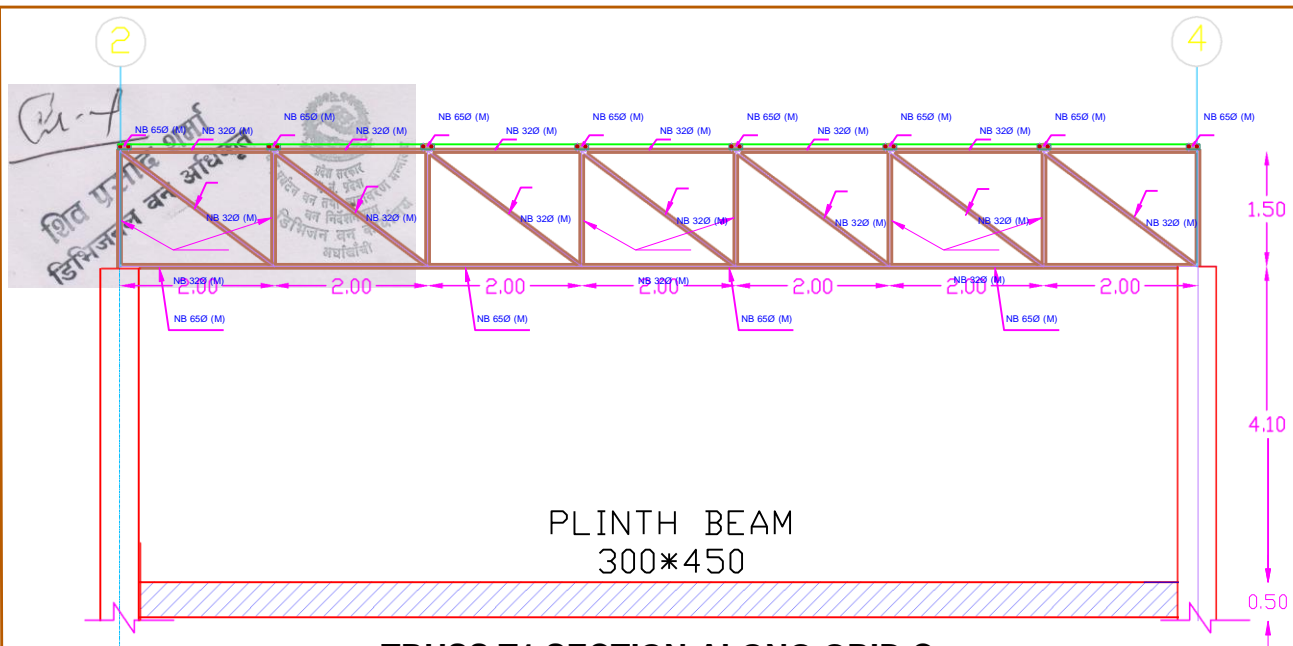

TRUSS T1 SECTION ALONG GRID C
Scale:-1:40

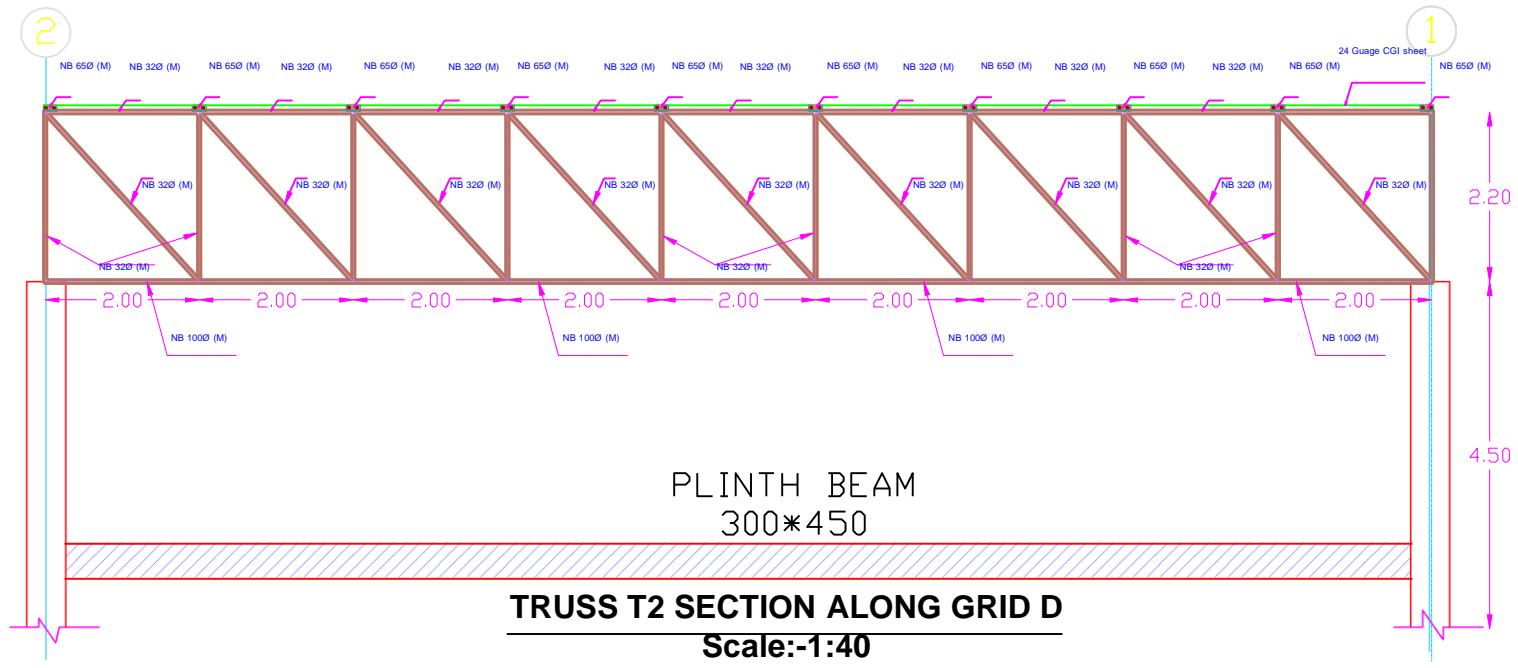

TRUSS T2 SECTION ALONG GRID D
Scale:-1:40

CLIENT: GOVERNMENT OF PROVINCE PROVINCE NO. 5  MINISTRY OF INDUSTRY, TOURISM, FOREST & ENVIRONMENT FOREST DIRECTORATE DIVISION FOREST OFFICE, ARGHAKHANCHI	STRUCTURAL DRAWINGS	SUBMITTED BY INTERFACE ENGINEERING PVT.LTD		Drawing No
	PROJECT: DETAILED DESIGN , COST ESTIMATE AND DRAWING OF MULTIPURPOSE AUDITORIUM HALL OF PANANI TAPOBHUMI, ARGHAKACHI	SCALE =	CHECKED BY	APPROVED BY
		Date 2019	RECOMMENDED BY	

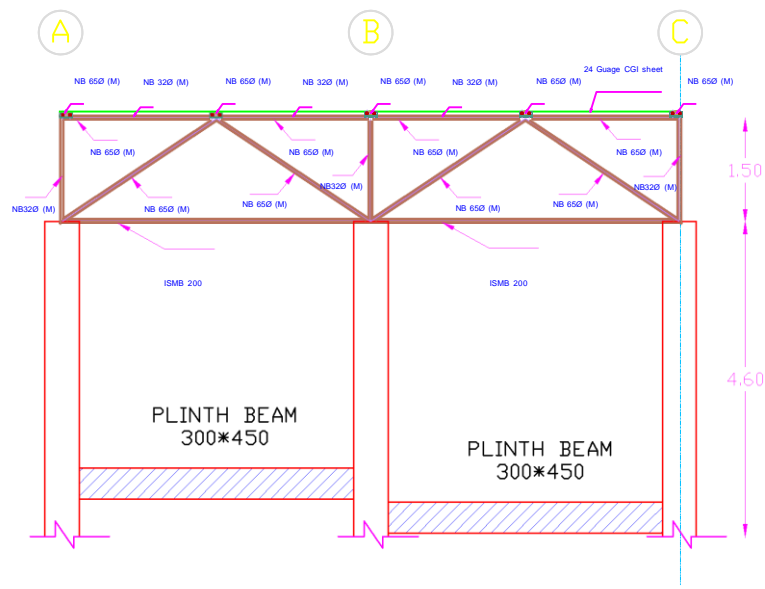
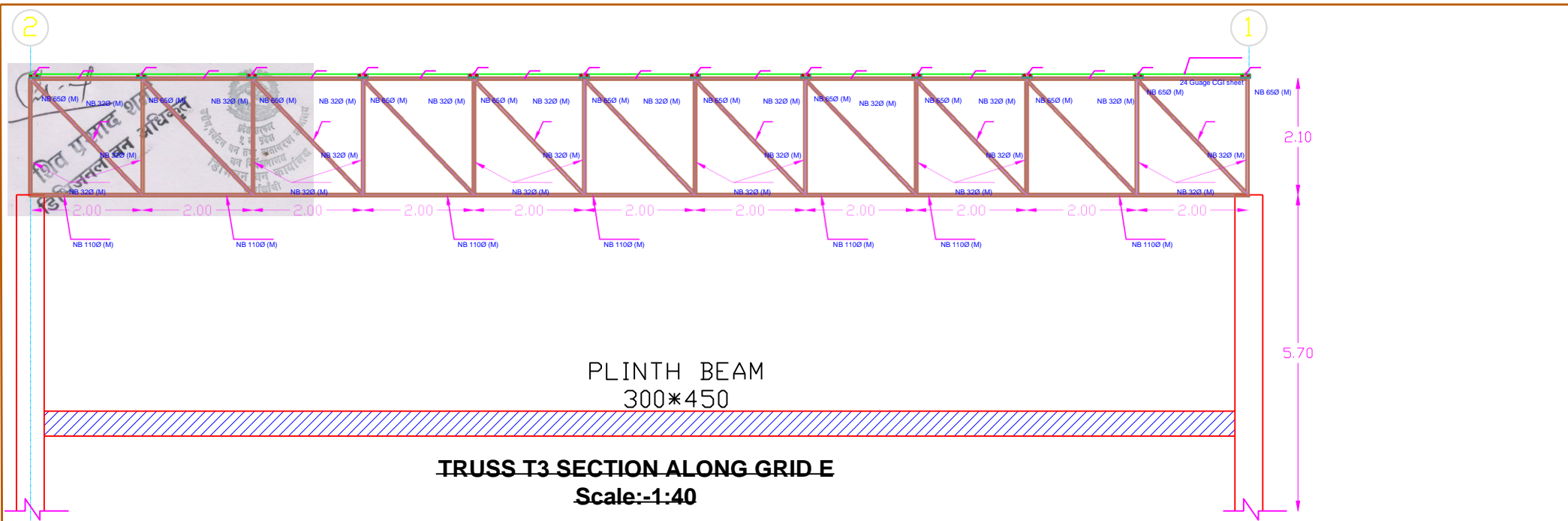

CLIENT:

 GOVERNMENT OF PROVINCE
 PROVINCE NO. 5
 MINISTRY OF INDUSTRY, TOURISM, FOREST & ENVIRONMENT
 FOREST DIRECTORATE
 DIVISION FOREST OFFICE, ARGHAKHANCHI

STRUCTURAL DRAWINGS

PROJECT:
 DETAILED DESIGN , COST ESTIMATE AND DRAWING OF MULTIPURPOSE AUDITORIUM HALL
 OF PANANI TAPOBHUMI, ARGHAKACHI

SCALC = CHECKED BY

Date 2019 RECCOMENDED BY APPROVED BY

Drawing No
ST-19
Size **A3**

2

1

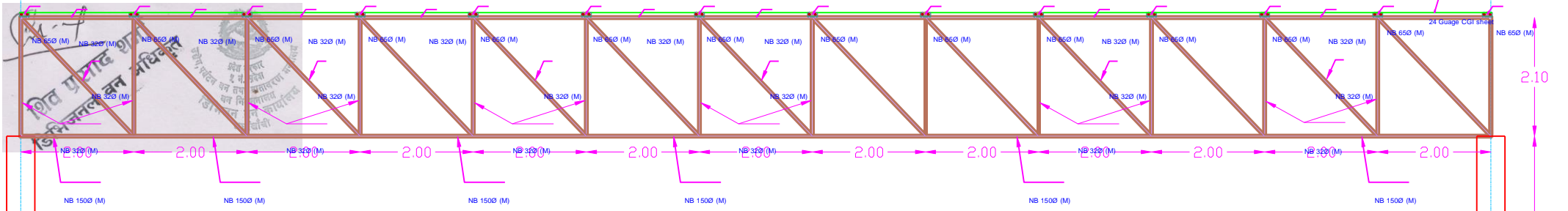

PLINTH BEAM
300*450

TRUSS T4 SECTION ALONG GRID F
Scale:-1:40

2

1

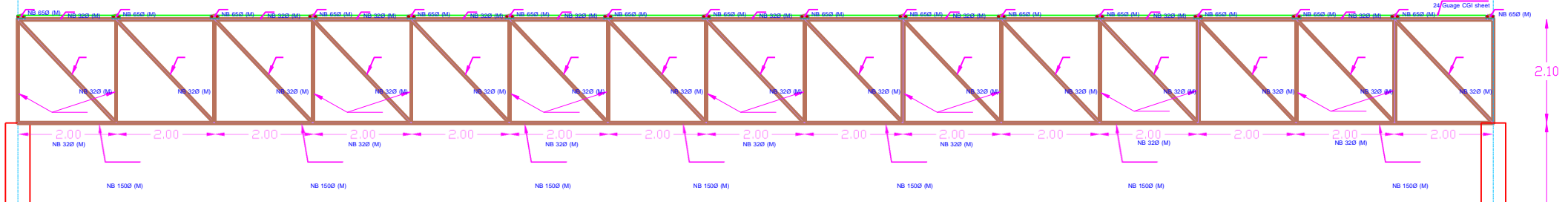

TRUSS T5 SECTION ALONG GRID G
Scale:-1:40

CLIENT:

 GOVERNMENT OF PROVINCE
 PROVINCE NO. 5
 MINISTRY OF INDUSTRY, TOURISM, FOREST & ENVIRONMENT
 FOREST DIRECTORATE
 DIVISION FOREST OFFICE, ARGHAKHANCHI

STRUCTURAL DRAWINGS

PROJECT:
 DETAILED DESIGN , COST ESTIMATE AND DRAWING OF MULTIPURPOSE AUDITORIM HALL
 OF PANANI TAPOBHUMI, ARGHAKACHI

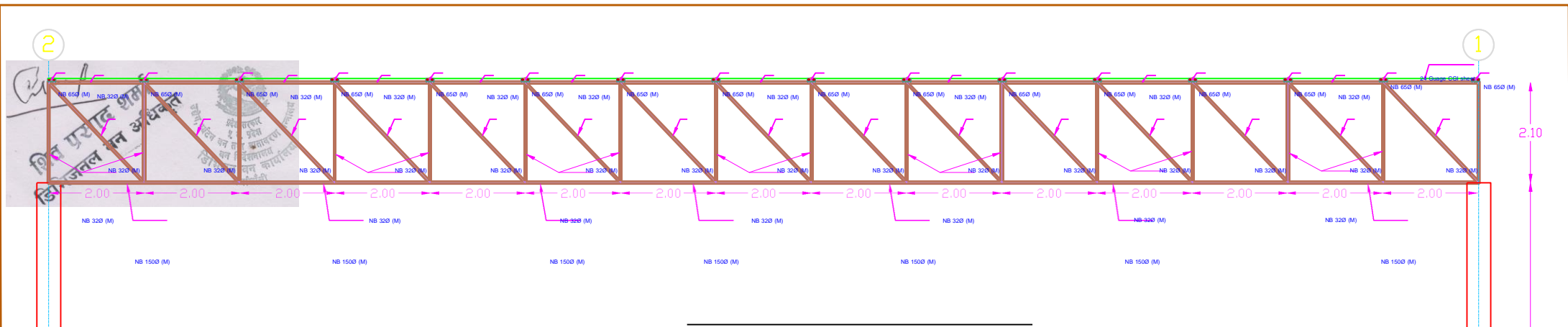
			Drawing No.	
			ST-20	
SCALE =	DATE :	2019	CHECKED BY:	
	RECOMMENDED BY:		APPROVED BY:	
			Size:	A3



TRUSS T5 SECTION ALONG GRID G
Scale:-1:40

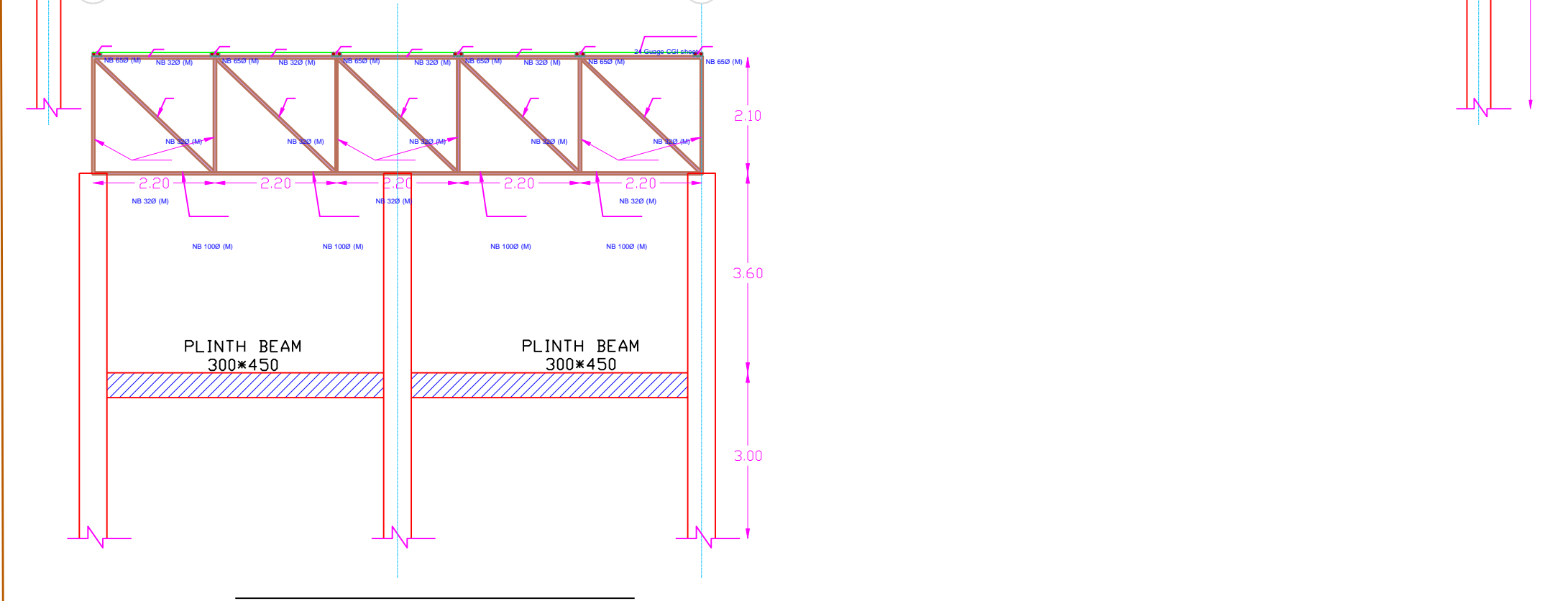

TRUSS T6 SECTION ALONG GRID H

CLIENT:  GOVERNMENT OF PROVINCE PROVINCE NO. 5 MINISTRY OF INDUSTRY, TOURISM, FOREST & ENVIRONMENT FOREST DIRECTORATE DIVISION FOREST OFFICE, ARGHAKHANCHI	Scale:-1:40	STRUCTURAL DRAWINGS		Drawing No		
		PROJECT: DETAILED DESIGN , COST ESTIMATE AND DRAWING OF MULTIPURPOSE AUDITORIM HALL OF PANANI TAPOBHUMI, ARGHAKACHI		SCALC =	CHECKED BY	ST-21
		Date 2019	RECCOMENDED BY	APPROVED BY	Size	A3

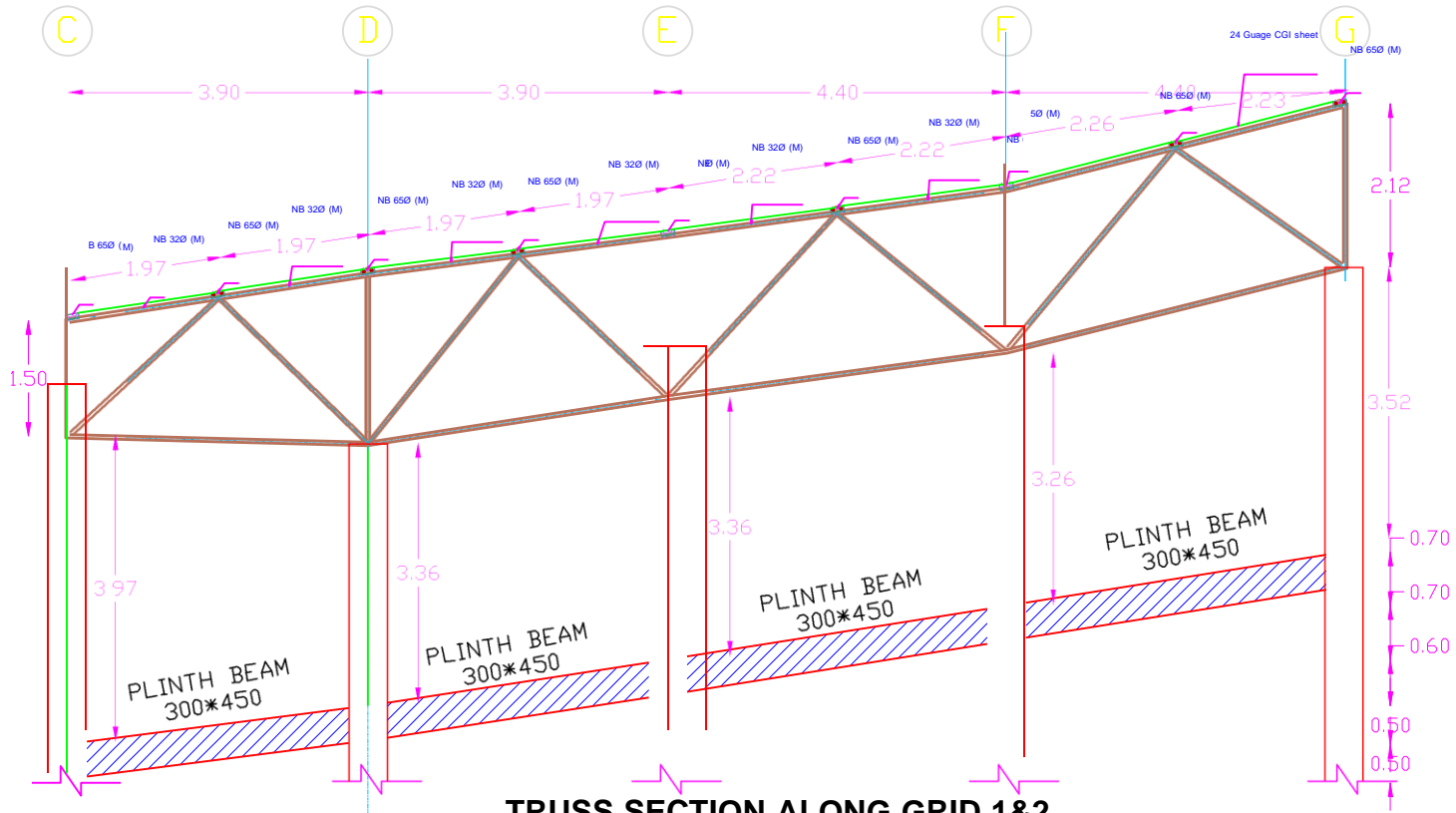
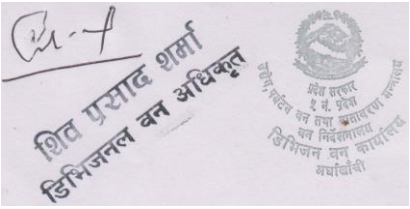

TRUSS SECTION ALONG GRID 1&2
Scale:-1:40

CLIENT:
 GOVERNMENT OF PROVINCE
 PROVINCE NO. 5
 MINISTRY OF INDUSTRY, TOURISM, FOREST & ENVIRONMENT
 FOREST DIRECTORATE
 DIVISION FOREST OFFICE, ARGHAKHANCHI

STRUCTURAL DRAWINGS

PROJECT:
 DETAILED DESIGN , COST ESTIMATE AND DRAWING OF MULTIPURPOSE AUDITORIUM HALL
 OF PANANI TAPOBHUMI, ARGHAKACHI

SCALE: _____
 DATE: 2019
 CHECKED BY: _____
 RECOMMENDED BY: _____
 APPROVED BY: _____

Drawing No
 ST-P2
 Size A3

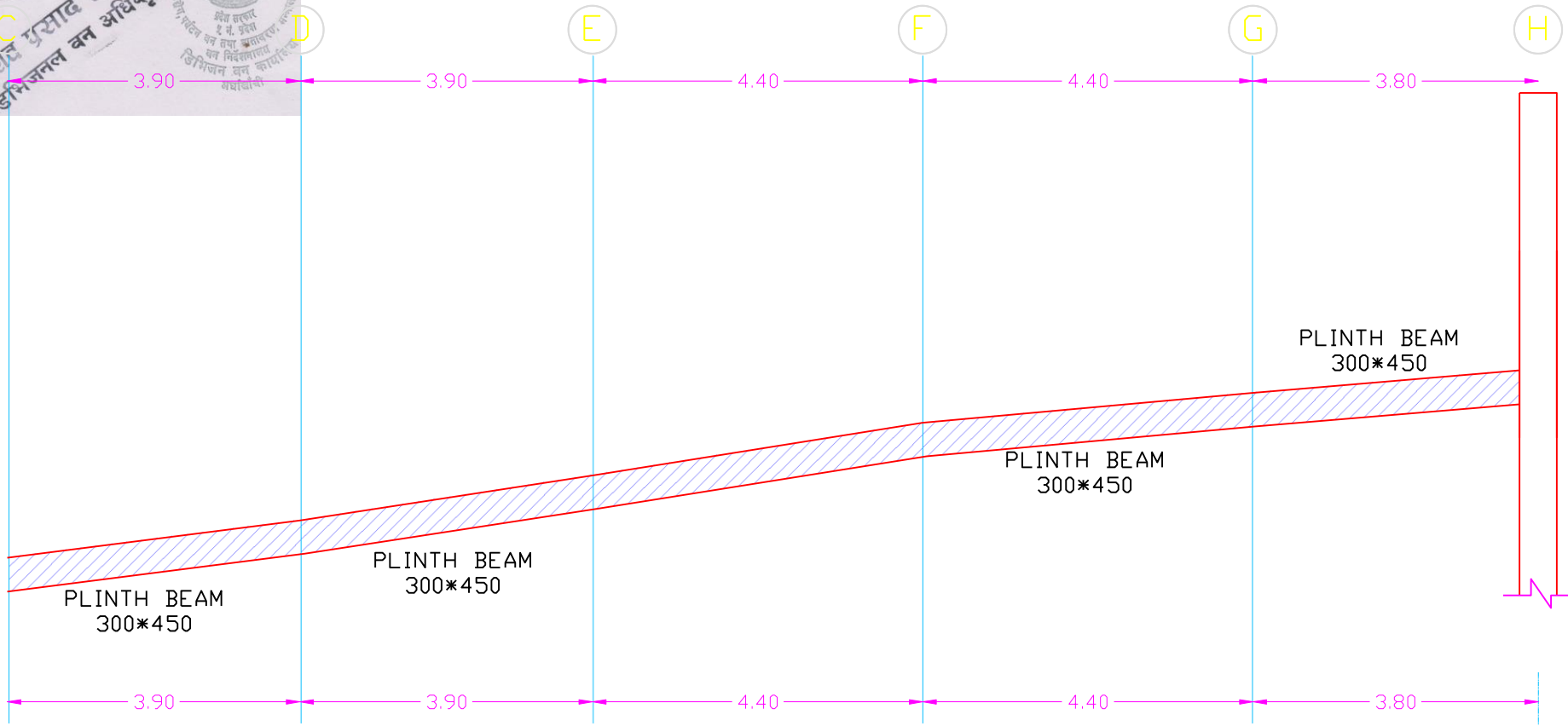
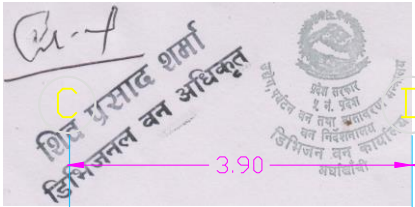

SECTION ALONG GRID 5&6
Scale:-1:40

CLIENT:
 GOVERNMENT OF PROVINCE
 PROVINCE NO. 5
 MINISTRY OF INDUSTRY, TOURISM, FOREST & ENVIRONMENT
 FOREST DIRECTORATE
 DIVISION FOREST OFFICE, ARGHAKHANCHI

STRUCTURAL DRAWINGS

PROJECT:
 DETAILED DESIGN , COST ESTIMATE AND DRAWING OF MULTIPURPOSE AUDITORIUM HALL
 OF PANANI TAPOBHUMI, ARGHAKHANCHI

SCALE =	CHIEF ENGINEER		Drawing No
Date 2019	RECOMMENDED BY	APPROVED BY	ST-23
			Size A3

Drawing No
ST-23
Size A3

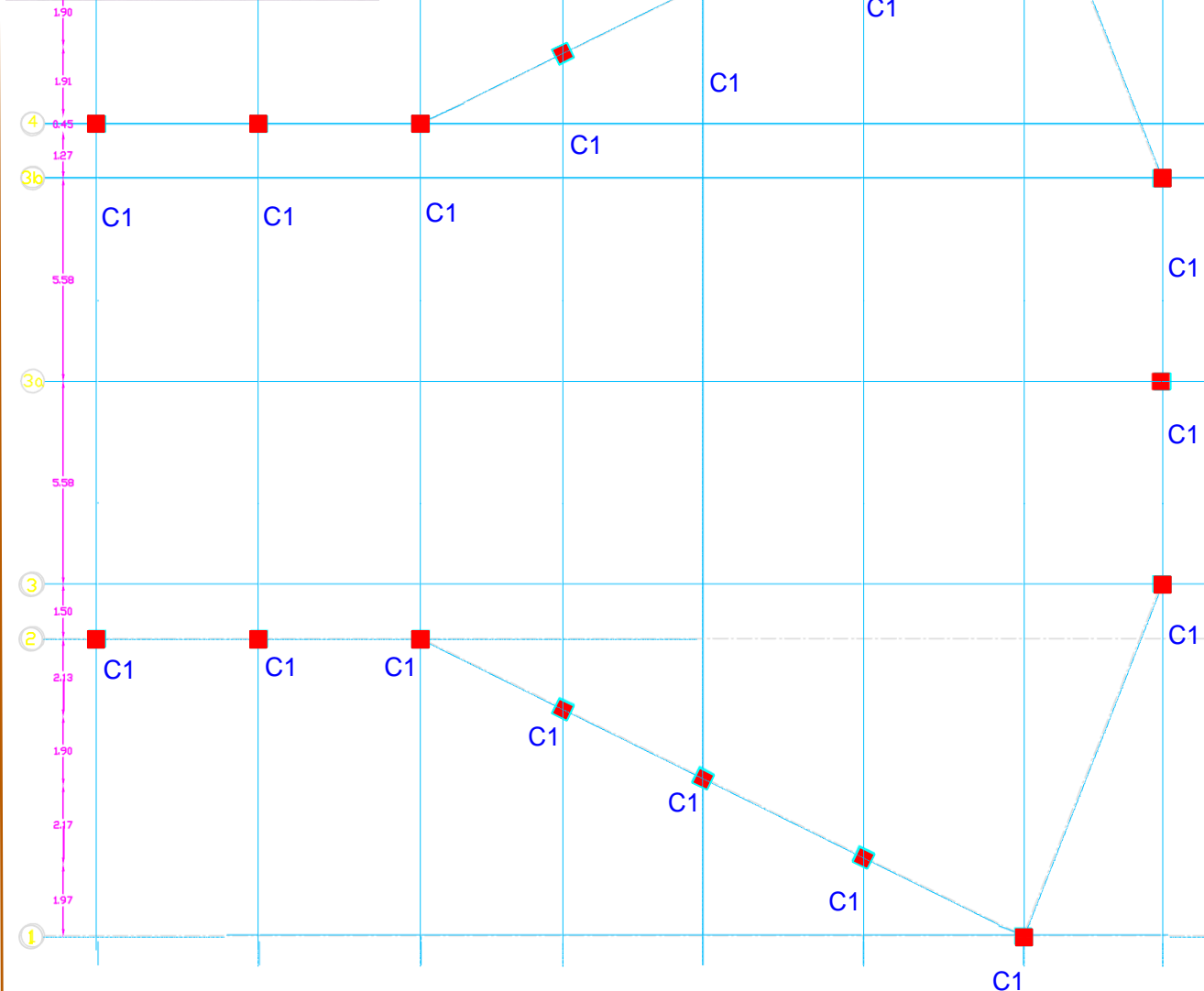
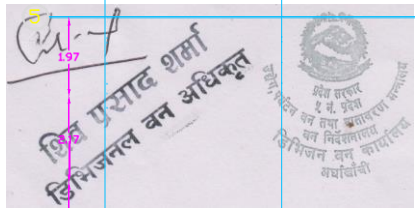

COLUMN LAYOUT PLAN

COLUMN REINFORCEMENT DETAIL			
S. NO.	GRADE OF CONCRETE	GRID - A	STIRRUPS
		COLUMN SIZE (450 x 450)	
1	M30 CONCRETE Fe 500		

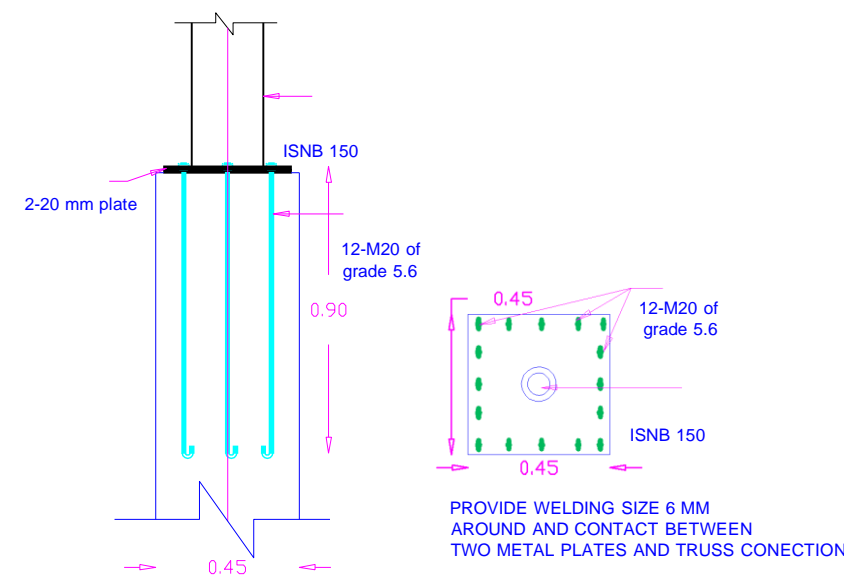

BASE AND BOLTS SECTION

(Scale= 1:20)

CLIENT: GOVERNMENT OF PROVINCE PROVINCE NO. 5 MINISTRY OF INDUSTRY, TOURISM, FOREST & ENVIRONMENT FOREST DIRECTORATE DIVISION FOREST OFFICE, ARGHAKHANCHI	STRUCTURAL DRAWINGS		Drawing No	
	PROJECT: DETAILED DESIGN , COST ESTIMATE AND DRAWING OF MULTIPURPOSE AUDITORIM HALL OF PANANI TAPOBHUMI, ARGHAKACHI		SCALE =	CHECKED BY
	Date 2019	RECOMMENDED BY	APPROVED BY	ST-03 Size A3

24-7

शिव प्रसाद शर्मा
डिभिजनल वन अधिकृत



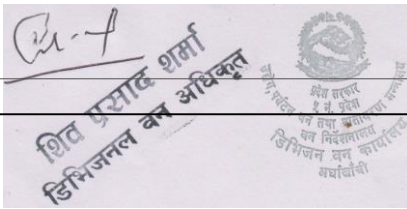

DESIGN AND DRAWING OF TOILET BLOCK

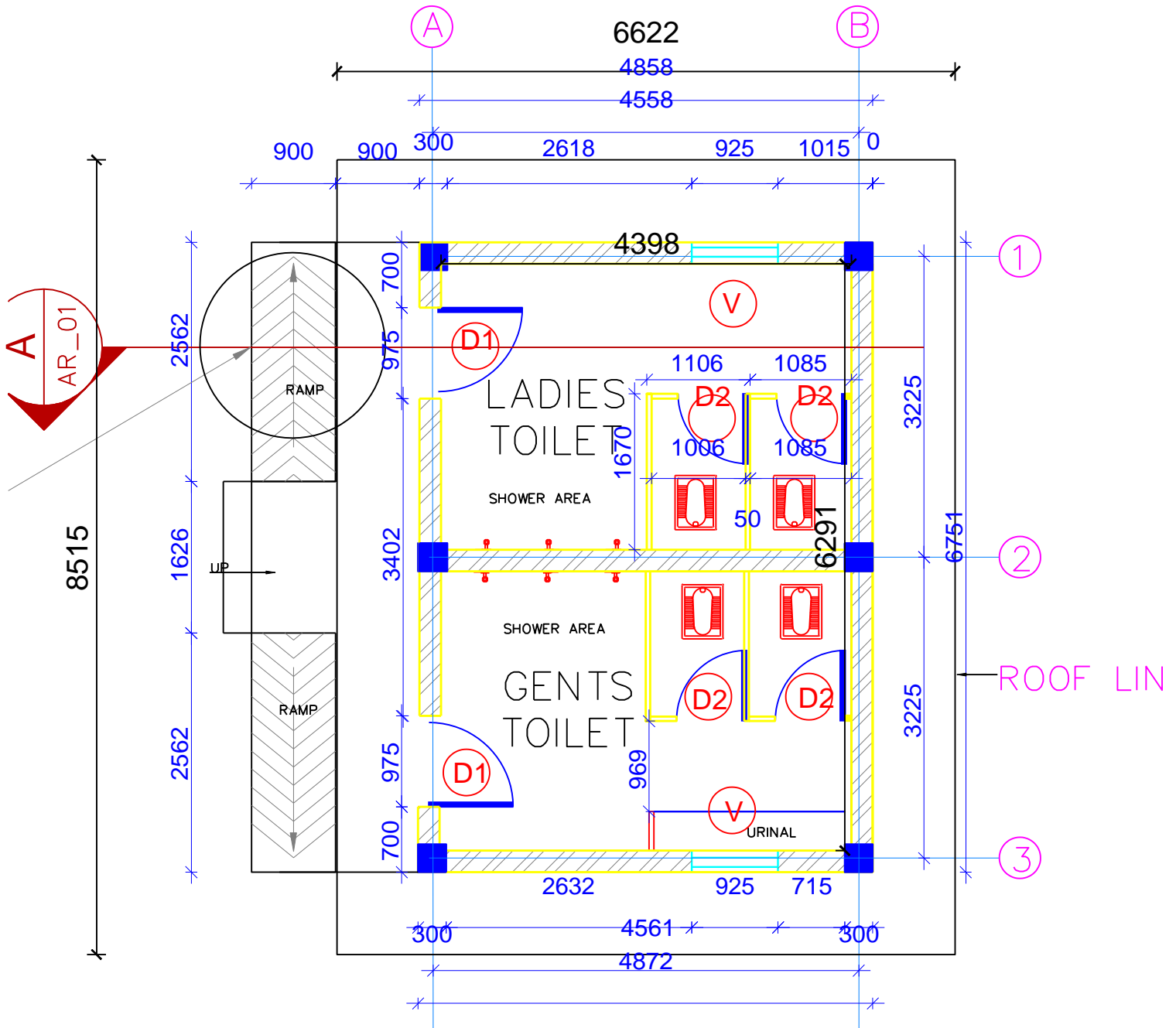
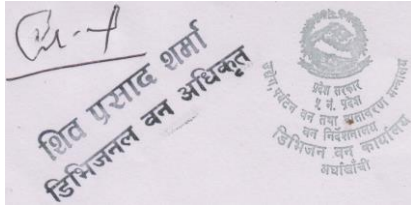

GROUND FLOOR PLAN
 FLOOR AREA: 32.88 SQ. M.

(Scale= 1:160)

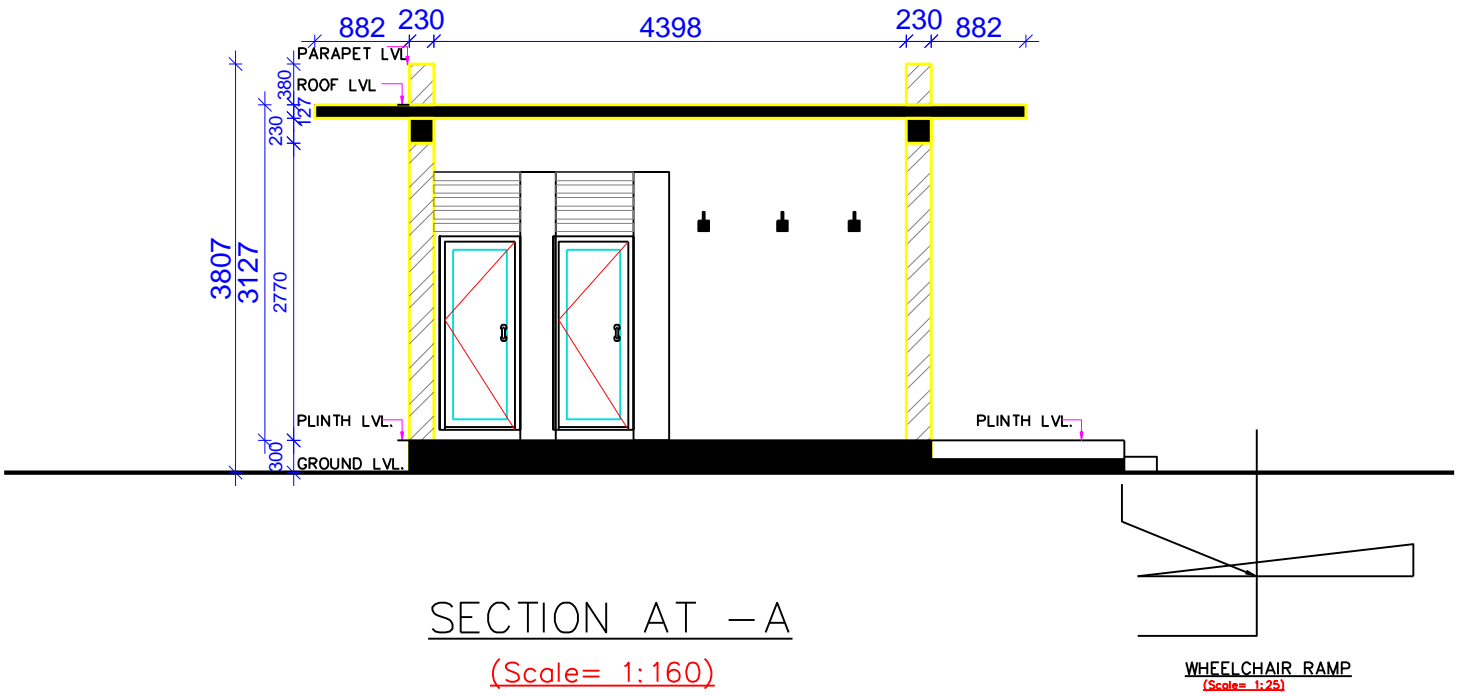
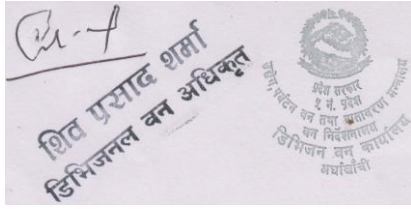

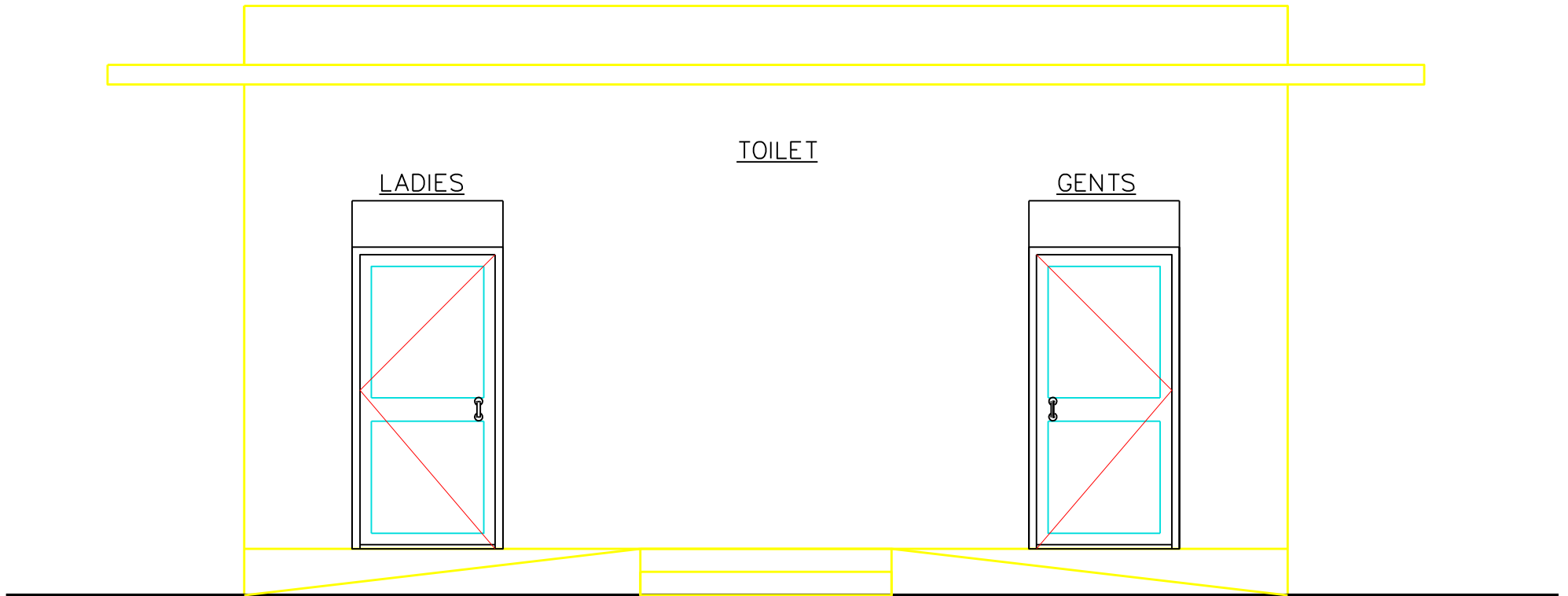

FRONT ELEVATION

(Scale= 1:160)

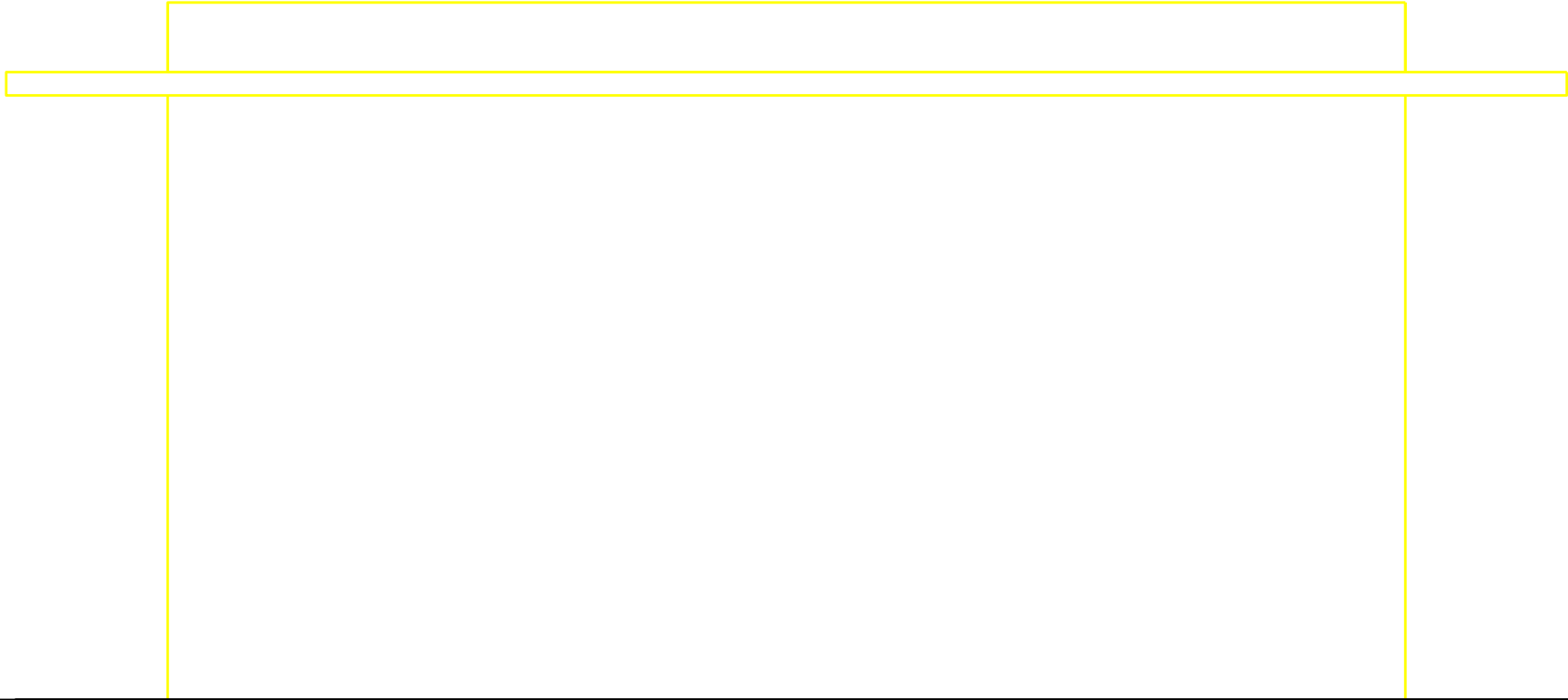
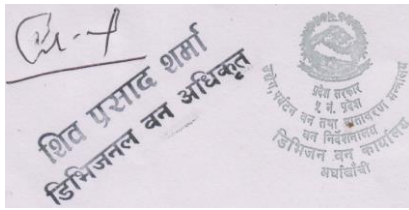

BACK ELEVATION

(Scale= 1:160)

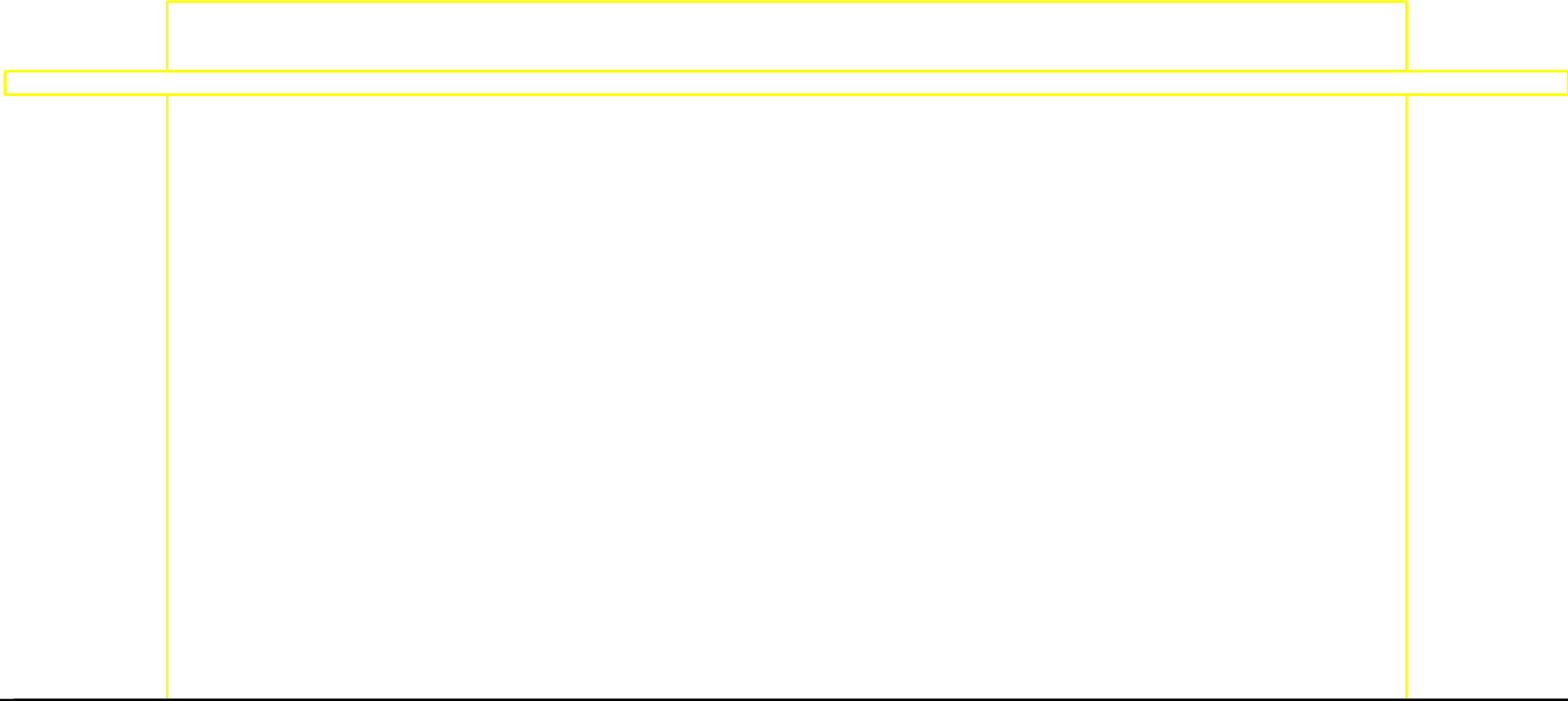
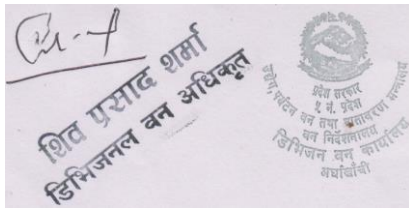

BACK ELEVATION

(Scale= 1:160)

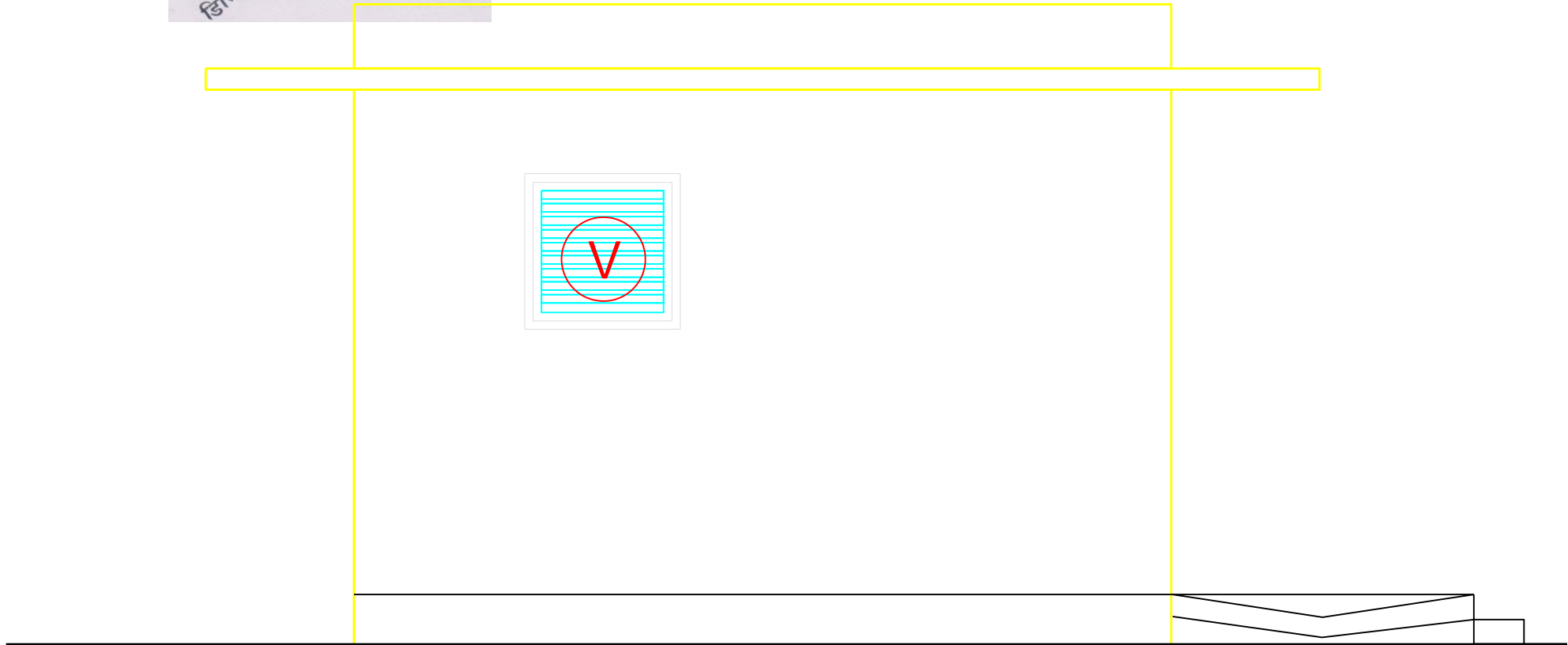
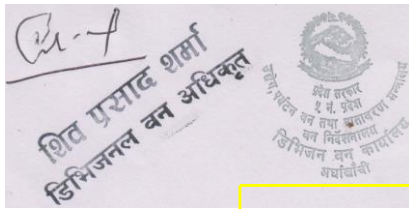

SIDE II ELEVATION

(Scale= 1:160)

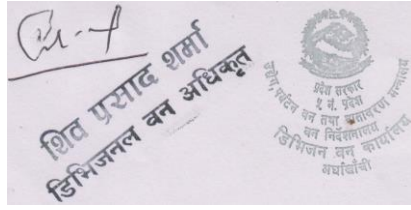

TOILET OPENING SCHEDULE

S.N	TYPE	SYMBOL	DOOR/WIND		REMARKS
			OW SIZE	NO.	
1	DOOR	D1	2100X975	2	ALUMINIUM
2	DOOR	D2	2100X750	4	ALUMINIUM
3	VENTILATION	V1	925X925	2	ALUMINIUM
			TOTAL	8	

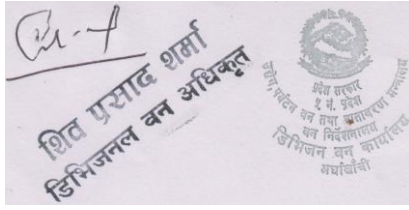

TOILET OPENING SCHEDULE

S.N	TYPE	SYMBOL	DOOR/WIND		REMARKS
			OW SIZE	NO.	
1	DOOR	D■	2100X975	2	ALUMINIUM
2	DOOR	02	2100X750	4	ALUMINIUM
3	VENTILATION	V■	925X925	2	ALUMINIUM
			TOTAL	8	

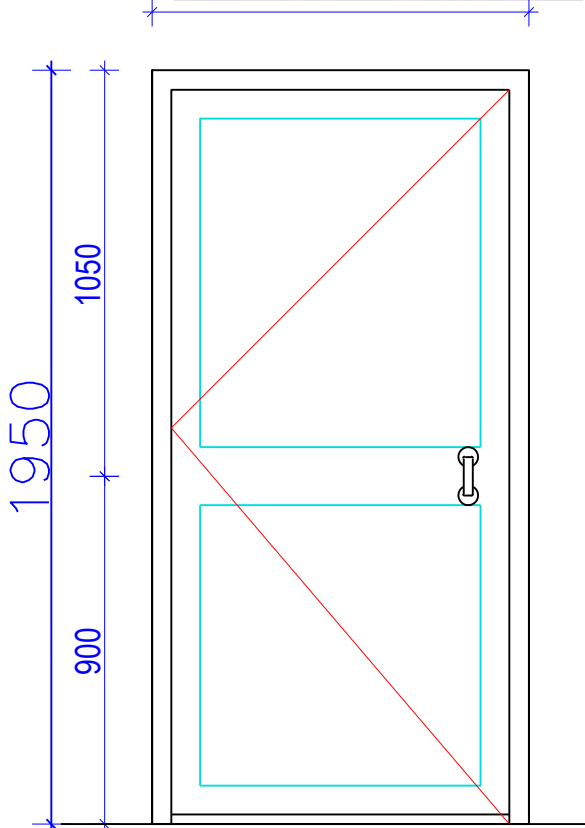
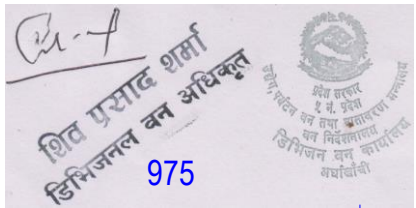

DOOR-D1 (4 Nos.)

(Scale= 1:25)

750

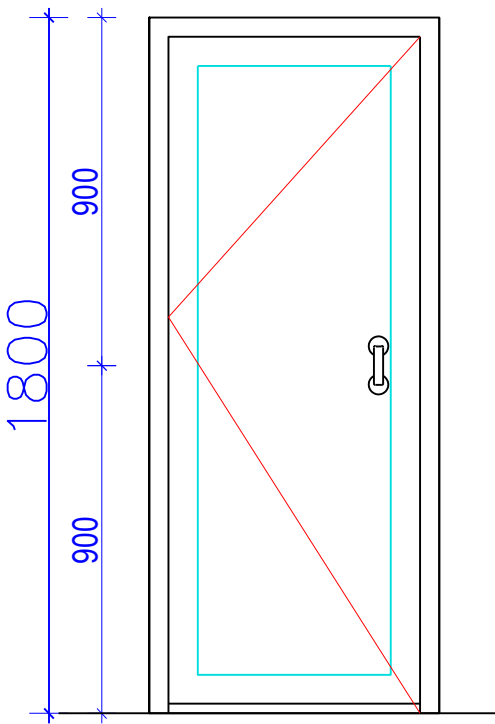

DOOR-D2 (4 Nos.)

(Scale= 1:25)

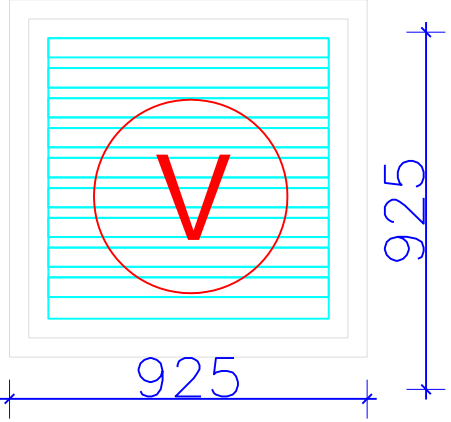

VENTILATION V (2 Nos.)

(Scale= 1:25)

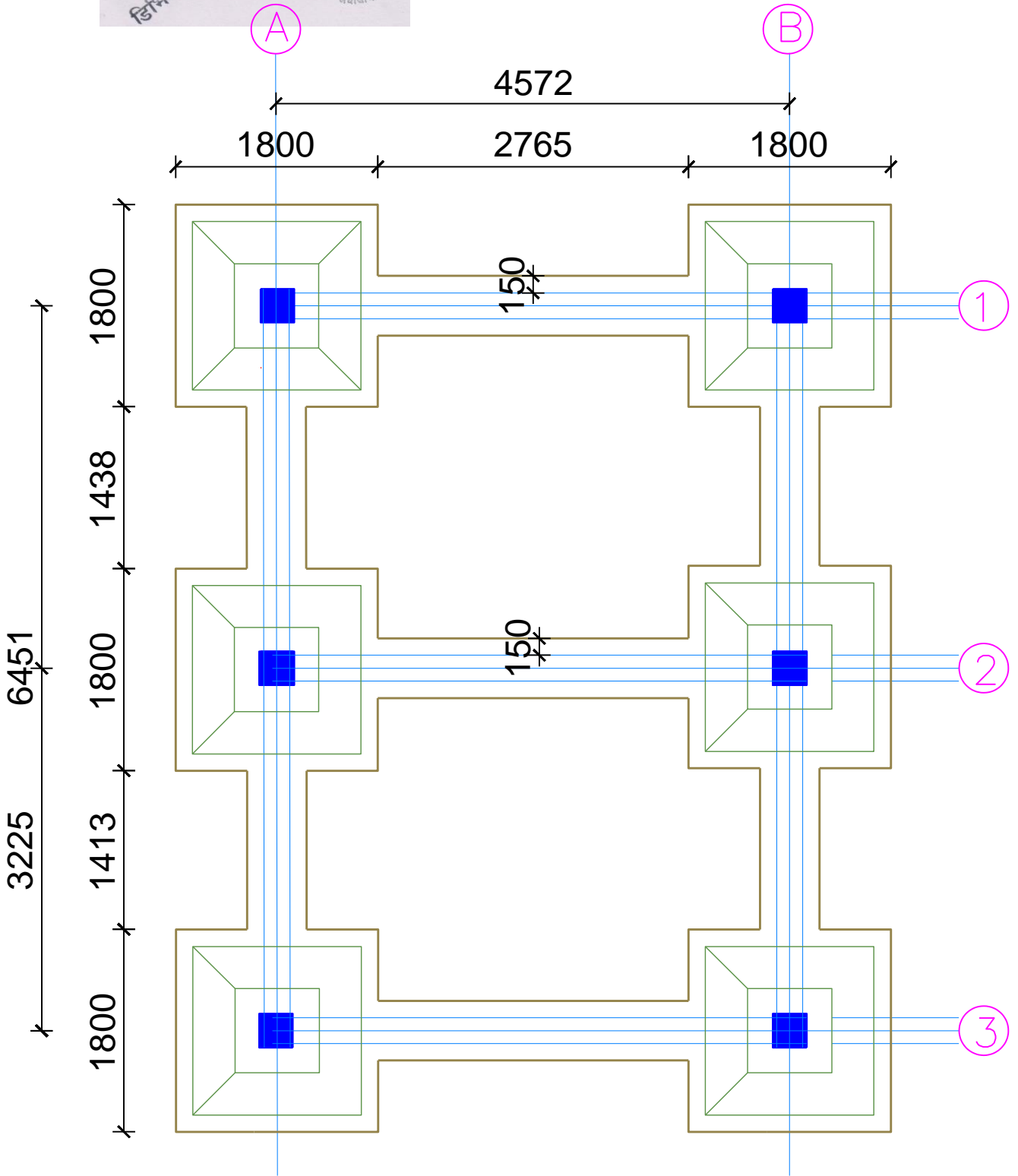
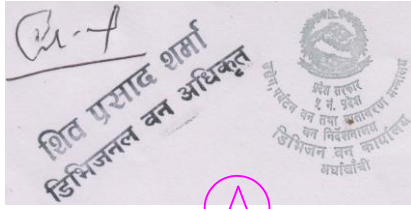

Foundation Layout Plan

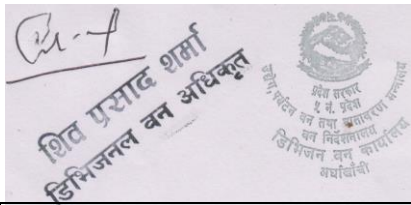

COLUMN REINFORCEMENT TABLE FOR GROUND FLOOR

GRID	GRID -1	GRID -2	GRID -3	STIRRUPS
GRID -B	<div style="display: flex; justify-content: center; align-items: center;"> <div style="margin-right: 10px;">300</div> </div> <p style="text-align: center; color: green;">4-16Ø+4-12Ø</p>	<div style="display: flex; justify-content: center; align-items: center;"> <div style="margin-right: 10px;">300</div> </div> <p style="text-align: center; color: green;">4-16Ø+4-12Ø</p>	<div style="display: flex; justify-content: center; align-items: center;"> <div style="margin-right: 10px;">300</div> </div> <p style="text-align: center; color: green;">4-16Ø+4-12Ø</p>	<div style="display: flex; justify-content: space-around;"> </div> <p style="text-align: center;">8mmØ@100mmc/c & 150mmcc</p>
GRID -A	<div style="display: flex; justify-content: center; align-items: center;"> <div style="margin-right: 10px;">300</div> </div> <p style="text-align: center; color: green;">4-16Ø+4-12Ø</p>	<div style="display: flex; justify-content: center; align-items: center;"> <div style="margin-right: 10px;">300</div> </div> <p style="text-align: center; color: green;">4-16Ø+4-12Ø</p>	<div style="display: flex; justify-content: center; align-items: center;"> <div style="margin-right: 10px;">300</div> </div> <p style="text-align: center; color: green;">4-16Ø+4-12Ø</p>	<div style="display: flex; justify-content: space-around;"> </div> <p style="text-align: center;">8mmØ@100mmc/c & 150mmcc</p>

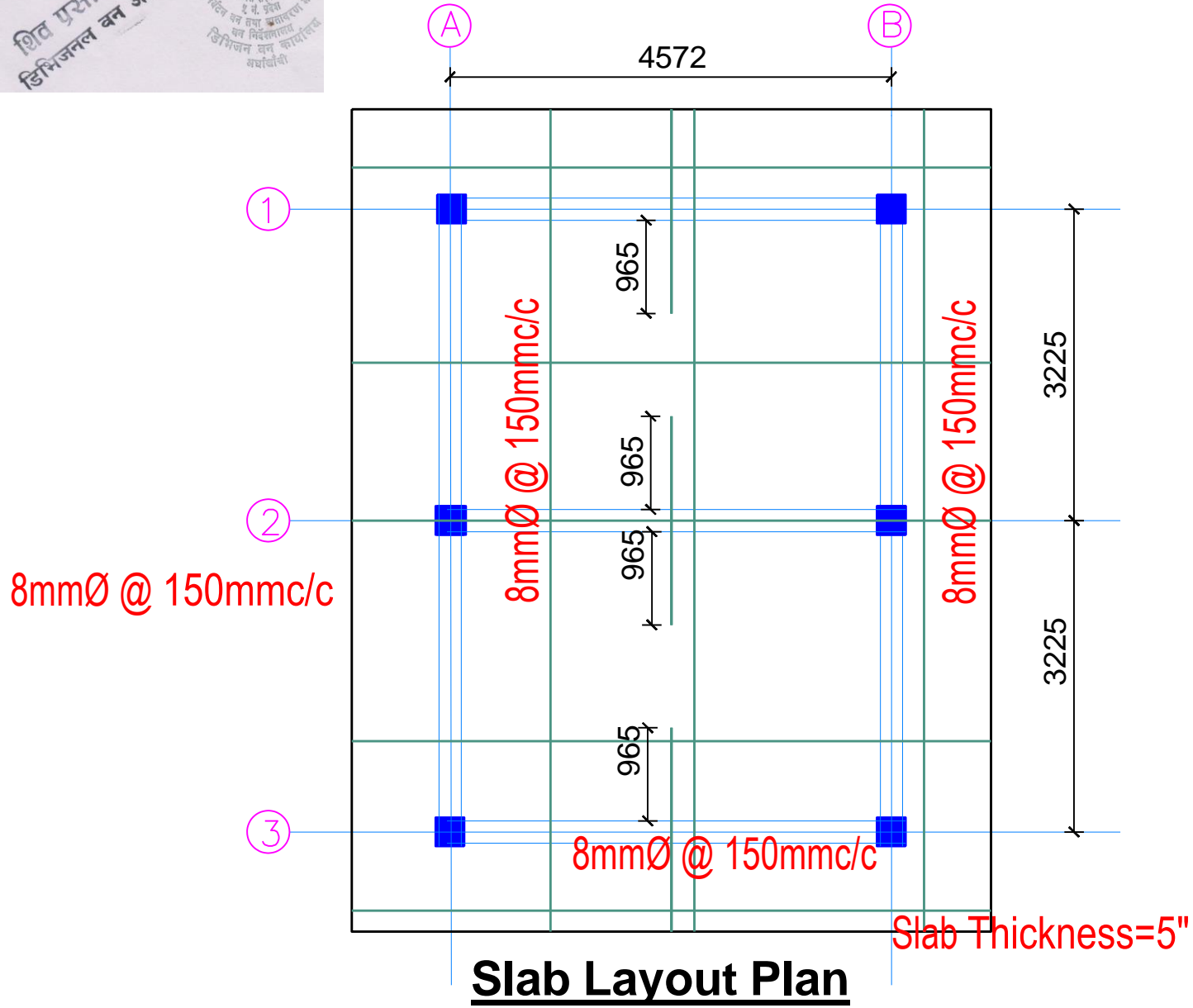
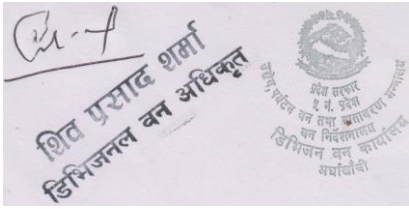

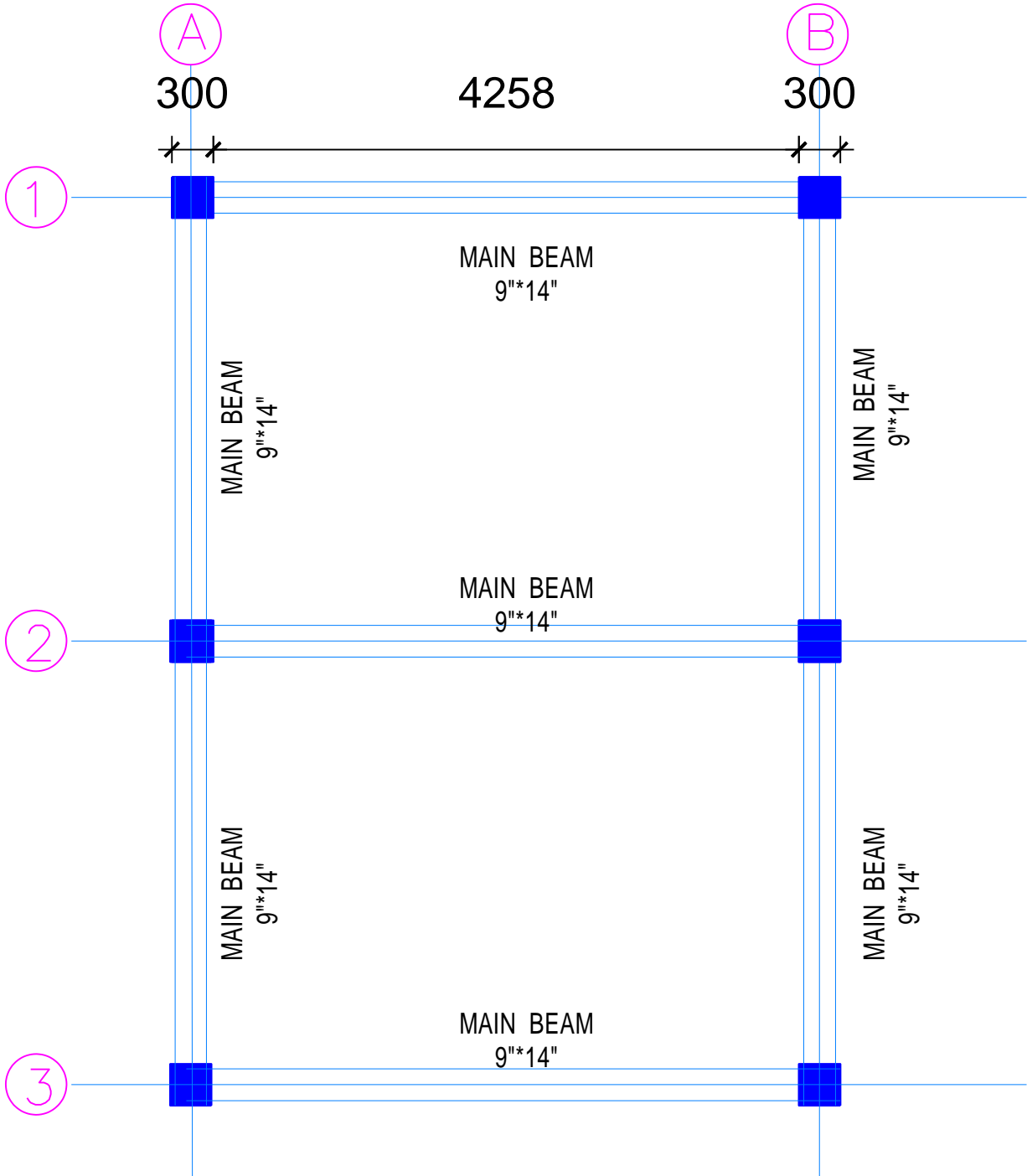
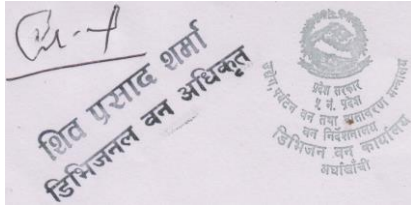

Beam Layout Plan

SECTION-VI
Bill of Quantities

Bill of Quantities

1 Provisional Sum

Procurement Item Details					
SL. No	Item Description	Unit	Quantity	Unit Rate(NPR)	Amount(NPR)
1	Supply of a hording board at a construction site of size 1.8m*1.2m showing all the necessary information of the project.	No	1.0	5000.0	5,000.00
2	Insurance of works, equipment, Contractor's workmen and employees and Third party Insurance against damage to other persons and property.	Ps	1.0	127000.0	127,000.00
3	Assurance of safety provisions for the contractors workmens and employees.	Ls	1.0	30000.0	30,000.00

2 Construction work

2.1 Building completion work

2.1.1 Other building completion work

Procurement Item Details						
SL. No	Item Description	Unit	Quantity	Bidder's Rate (NPR)	Bidder's Rate (in words)	Total Amount (NPR)
1	Preparation of the site by clearing out all the debris, cleaning the surface, cutting existing trees/bushes etc. and to make site ready for setting out as per drawing and approval of Engineer.	Sqm	1168.65			
2	Earthwork in excavation in foundation for lift upto 6m including timbering, pumping out water from the foundation trench, stocking the soil upto 30m from the edge of foundation, filling the excavated soil & clean and grubbb of excess soil upto a lead of 30m as per instruction and direction all complete	Cum	448.1			
3	Earth work in filling in foundation trenches and floor with materials including compaction with sprinkling water as per the specification and approval of Engineer	Cum	290.97			
4	Supply, laying and compacting Stone soling in foundation works complete to level as per the drawing, specification and appoval of Engineer	Cum	177.4			
5	Supplying, laying and compacting coarse sand in layers in floors including levelling, sprinkling water, compaction all complete as per drawing, specification and approval of Engineer.	Cum	32.63			
6	Provide and place first class chimney made brick work through out length with 1:6 cement sand mortar in perfect line and level incuding wetting the bricks, packing the joints and cutting the works in all types and thickness of walls all complete work	Cum	32.64			

Procurement Item Details

SL. No	Item Description	Unit	Quantity	Bidder's Rate (NPR)	Bidder's Rate (in words)	Total Amount (NPR)
7	Provide and place brick masonry through out length with 1:4 cement sand mortar in perfect line and level including, packing the joints and cutting the works in all types and thickness of walls all complete work	Cum	18.71			
8	75mm EPS(Eco) sandwich panels with necessary installation including metal works	Sqm	1067.2			
9	Providing and laying machine mixed Plain Cement Concrete of nominal mix 1:3:6 (1 cement : 3 sand : 6 coarse aggregate) for leveling course in foundations and under floor of building, etc. in all level with broken stone aggregate of size not more than 25 mm of approved quality including formwork wherever necessary, dewatering, batching, mixing, transporting, placing, compacting, curing, including all lead and lift, etc. all complete as per drawings, specifications and the instructions of the Engineer.	Cum	87.77			
10	Supply, mixing, transporting, placing, compaction, protection, levelling and curing M-25 concrete(1:1:2) for RCC works as per requirement all complete as per drawing, specification and approval of Engineer	Cum	248.65			
11	Supply, mixing, transporting, placing, compaction, protection, levelling and curing M-15 concrete(1:2:4) for RCC works as per requirement all complete as per drawing, specification and approval of Engineer	Cum	1.27			
12	Supply, mixing, transporting, placing, compaction, protection, levelling and curing M-20 concrete(1:1.5:3) for RCC works as per requirement all complete as per drawing, specification and approval of Engineer	Cum	16.54			
13	Supplying and laying centering, shuttering of various pattern formworks with 12 mm thick water proof ply wood & steel adjustable props for all kinds of RCC works for foundations, columns, shear walls, beams, slab, staircase, lintel, sill, pergola, including nails, propping scaffolding, staging, supporting and bracing in proper lines and level, sealing the joints with heavy duty brown self adhesive tape, aligning to line and levels including Ties, PVC Spacer, Providing openings/ cutouts/ pockets, applying De-shuttering chemical, De-shuttering as approved by the Engineer etc., complete at all levels as per drawing, specifications and instructions of the Engineer.	Sqm	1046.89			

Procurement Item Details

SL. No	Item Description	Unit	Quantity	Bidder's Rate (NPR)	Bidder's Rate (in words)	Total Amount (NPR)
14	Providing and fixing in position Fe 500 steel reinforcement of various diameter conforming to relevant IS code in R.C.C. works including straightening, cutting, bending, binding with 20 SWG annealed wire for tying the reinforcement bars at each junctions (binding wire shall not be measured separately) including all waste and cut pieces, provision for adequate numbers of spacers, chairs, providing and placing cement mortar (1:1) cover blocks to keep the bars in intended position at all levels all complete as per drawings, specifications and instructions of the Engineer. (Authorized lap length and for the bar length exceeding 10 meter in length shall be measured for the payment).	Kg	41204.6			
15	Providing and fixing in position wooden frames in doors and windows of specified section (75*100 mm) of seasoned salwood assembled with wooden nails including cost of hold fast, screws etc and applying two coats of bitumen paint to the surface contacting to walls or other works etc all complete as per drawings, specification and instruction of the Engineer.	Cum	0.47			
16	Supply and fixing of Panned window / door shutter providing 38mm thick 100 X 75mm size sal wood with good finishing as per drawing, specification and instruction.	Sqm	33.85			
17	Aluminium sliding window with ventilation with naturally anodized aluminium (section 101.6*44*15) mm3 with 5 mm thick clear glass and steel net including materials and labors and fitting and fixing all complete as directed by the site engineer	Sqm	70.74			
18	Supply, mixing, laying and compacting 38mm thick concrete floor (1:2:4) on floors including materials, labour, curing etc all complete as per drawing, specification and approval of the Engineer	Sqm	702.91			
19	Supply, mixing and placing of 3mm thick (or more) cement sand punning 1:1 over screed, trowel finished in perfect line and level including materials, labour, curing etc all complete as per drawing, specification and approval of the Engineer	Sqm	12.85			

Procurement Item Details						
SL. No	Item Description	Unit	Quantity	Bidder's Rate (NPR)	Bidder's Rate (in words)	Total Amount (NPR)
20	Providing and laying 300*300mm size, 6.8mm minimum thick 1st class quality sparklet non glazed floor tiles over and including the cost of 20 mm 1:3 c/s screed with neat cement slurry, rubbing and polishing complete finishing including for skirting also as per design, drawing, specifications, standard and instruction of engineer.	Sqm	58.4			
21	Providing and laying 200*300mm size, 5.0mm minimum thick 1st class quality glazed wall tiles over and including the cost of 18 mm 1:3 c/s rough plaster with neat cement slurry, rubbing and polishing complete finishing as per design, drawing, specifications, standard and instruction of engineer..	Sqm	84.36			
22	Supplying, Fabrication and installation of Truss in proper line,level and plumb as per the design including application of red oxide	Kg	3282.53			
23	Colour Coated CGI Sheet Works: 24 guage 0.5mm CGI sheet roofing including fixing in proper shape & size with all necessary rails, screws, bolts & nuts washers, J & L hocks etc (everything should be galvanised) as per drawing & instruction of the Engineer, all complete.	Sqm	620.01			
24	Providing and Fixing of coloured plain sheet gutter (0.50mm thick, 150mm width & 40x3mm iron bracket, nut bolt & washer)	Rm	84.48			
25	Supply and fixing of 12.5 mm Gypsum board(Flashing sheet)for false ceiling and walls of covered hall all complete	Sqm	619.83			
26	Supply and fitting of stainless steel railing with 50 mm dia post 1m c/c centre,50 mm dia hand rail, 25 mm dia members in 3 horizontal layers;4 rows in total including labor charge all complete as directed by the engineer	Rm	6.0			

2.1.2 Plastering work

Procurement Item Details						
SL. No	Item Description	Unit	Quantity	Bidder's Rate (NPR)	Bidder's Rate (in words)	Total Amount (NPR)
1	Providing & laying 12.5 mm cement sand plaster (1:4) on walls and ceiling of good finish including racking the joints,wetting the surface and curing the work all complete	Sqm	222.61			
2	Providing & laying 20mm cement sand plaster (1:4) on walls and ceiling of good finish including racking the joints,wetting the surface and curing the work all complete	Sqm	70.72			

2.1.3 Painting and glazing work

Procurement Item Details						
SL. No	Item Description	Unit	Quantity	Bidder's Rate (NPR)	Bidder's Rate (in words)	Total Amount (NPR)
1	Provide and place two or more coats of wall putty of approved color over one coat of primer all complete as per specification and instruction of the Engineer	Sqm	2619.8			
2	Provide and place two or more coats of destemper paint of approved color over one coat of primer all complete as per specification and instruction of the Engineer	SQm	1400.97			
3	Provide and place two or more coats of weather coat paint of approved color over one coat of primer on plastered surface all complete as per the specification and approval of Engineer	Sqm	1152.34			
4	Provide and place two or more coats of emulsion paint of approved color over one coat of primer all complete as per specification and instruction of the Engineer	Sqm	122.99			

2.2 Building installation work

2.2.1 Electrical installation work

Procurement Item Details						
SL. No	Item Description	Unit	Quantity	Bidder's Rate (NPR)	Bidder's Rate (in words)	Total Amount (NPR)
1	Electrical and Sanitation Works	job	1.0			

Total of Procurement Items

Total Item Price						
VAT						
Grand Total						